

trophon® EPR and trophon2®

## Compatible Ultrasound Probes List

The probes on this list have been approved for use with the trophon® EPR and / or trophon®2 device(s) following extensive compatibility testing performed in conjunction with the probe Original Equipment Manufacturers (OEMs). Figure 1 demonstrates Nanosonics' rigorous probe compatibility program.

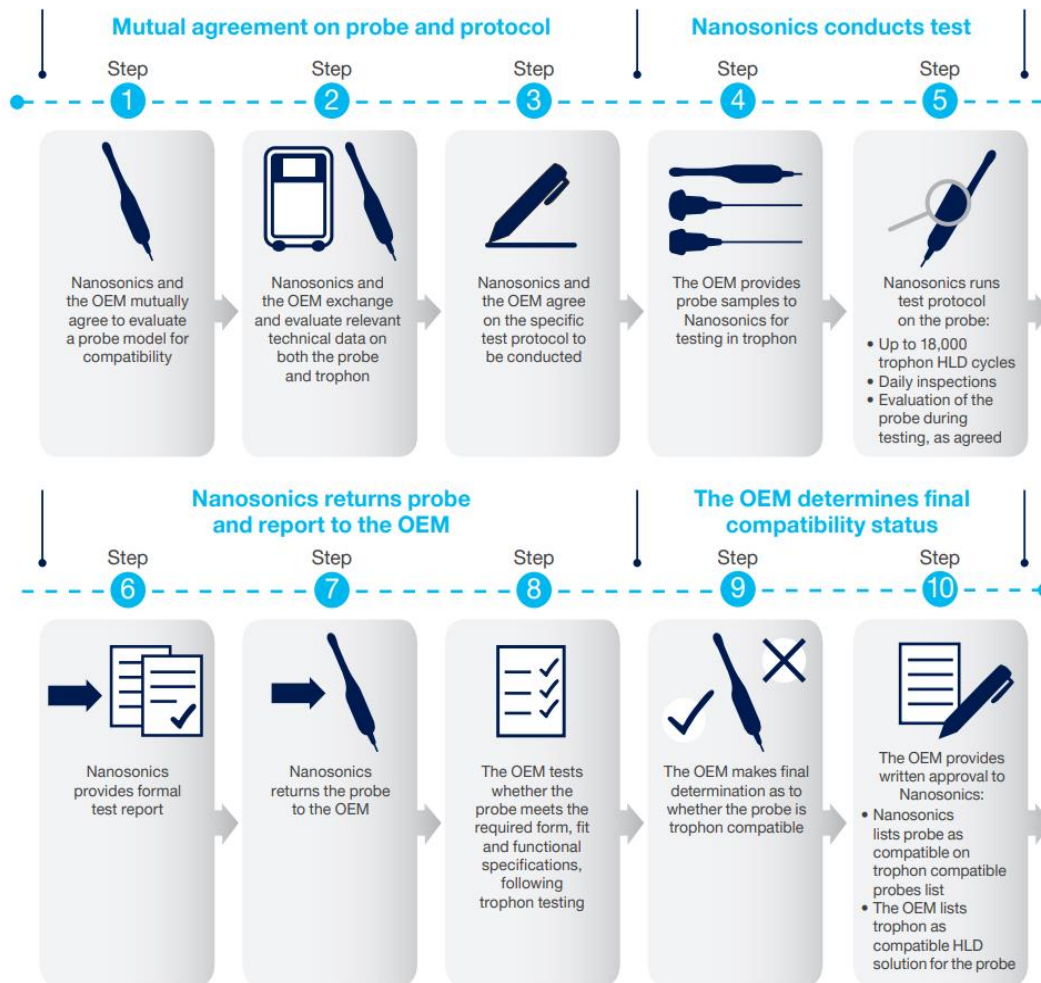

Figure 1

**Only probes that have been jointly approved and endorsed for compatibility by an OEM and Nanosonics are added to the trophon EPR and trophon2 Compatible Ultrasound Probe List.**

Approved probes are listed by manufacturer, series (Series), if applicable and then model (Model) number in the tables below.

Please check your probe(s) compatibility with the trophon EPR and trophon2 devices, indicated by: '✓' in the corresponding column of the table.

**Note:** Refer to the probe manufacturer's Instructions for Use (IFU) for information on the level of reprocessing required following the clinical use case of the probe. Probes requiring sterilisation for terminal reprocessing may use high level disinfection (HLD) as an intermediate step, to reduce bioburden prior to sterilisation. In

some cases where a probe requires sterilisation, but sterilisation is not possible, HLD of the probe and use with a sterile sheath may be considered.

### Special Conditions:

Model types labelled with symbols have special conditions when used with the trophon EPR and trophon2 devices.

Please take note of these special conditions when using these probes.

- <sup>1</sup> Prosonic (L5-10/40EPN): Only probes manufactured after December 30, 2011 are compatible.
- <sup>2</sup> Ultrasonix (L14-5/38): Only transducers with the serial number format TRA1.1-L145RP.xxx are compatible. If uncertain, confirm with your Ultrasonix representative.
- <sup>3</sup> Hitachi Aloka Medical: Where the serial number is specified in the list with brackets e.g. (M00621~), only probes with these serial numbers are compatible for use for this probe model.
- <sup>4</sup> These probes contain lumens that cannot be high level disinfected in trophon EPR or trophon2 devices. For disinfection of the lumens, refer to the probe original equipment manufacturers' IFU for reprocessing information. In USA, Canada and Japan, trophon EPR and trophon2 devices can be used to high level disinfect the external surfaces of these probes only.
- <sup>5</sup> EchoNous (Kosmos Torso/Kosmos Torso – ONE): EMC Suppressor shall be loaded inside the chamber, below the cable clamp.
- <sup>6</sup> Siemens Freestyle wireless probe range: Battery must be removed prior to disinfection.

- **CPP** The trophon CPP (Curved Probe Positioner) is an accessory to the trophon EPR device to support the positioning of approved curved probes in the device chamber. Refer to the trophon CPP IFU for more information on setup and use.

**Note:** trophon CPP is NOT required for the trophon2 device.

- **T** The trophon EPR T-Clamp (see Figure 2 below) is available for identified ultrasound probe cables. Please contact your trophon EPR representative for further information, or request a T-Clamp.

**Note:** T-Clamp is NOT required for the trophon2 device.

- **IPP** The trophon2 Integrated Probe Positioner (IPP) is a fully integrated mechanism in the trophon2 device (see Figure 3 below) that improves the positioning of all approved curved probes in the trophon2 chamber. Refer to the trophon2 User Manual for information on how to use the IPP.

- **WUPH-A** The trophon Wireless Ultrasound Probe Holder-A (WUPH-A) holds a compatible wireless ultrasound probe in the trophon chamber. It is suitable for use with both trophon EPR and trophon2 devices (see Figure 4 and Figure 5 respectively).

**Note:** The trophon WUPH-A is available in selected markets. Contact a Nanosonics representative for further information.

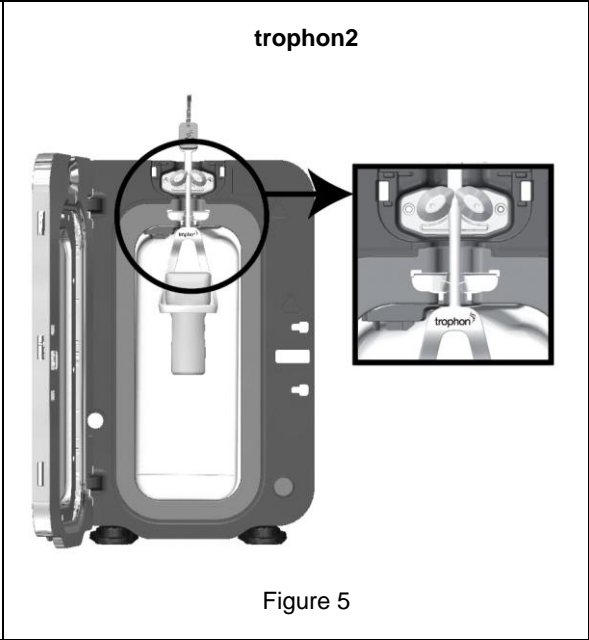
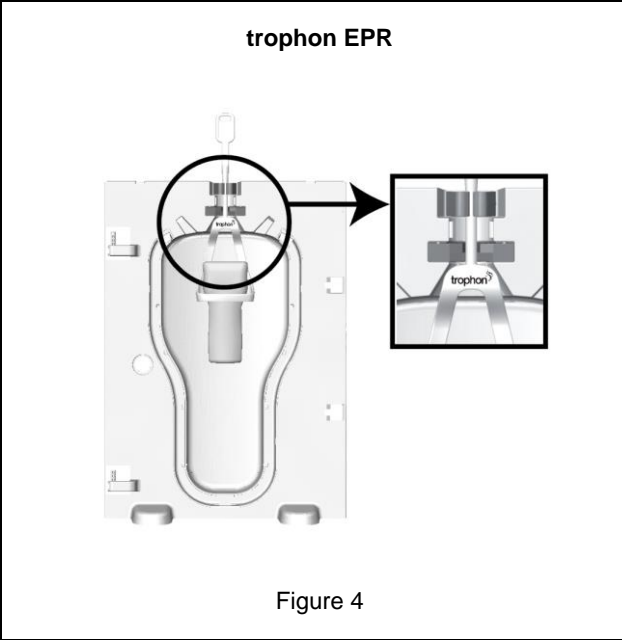
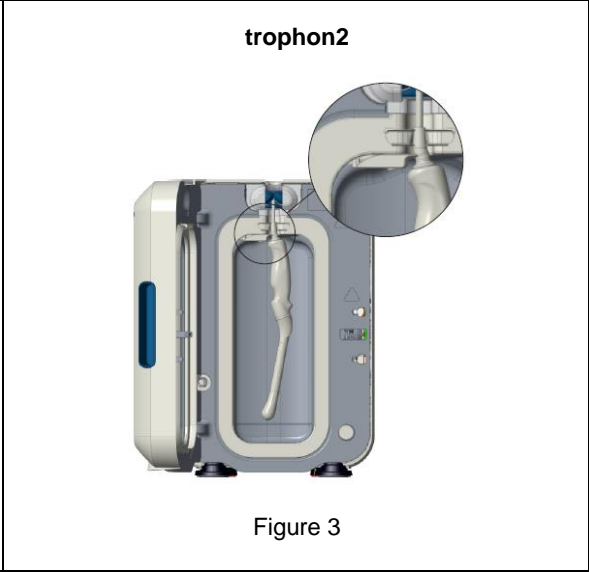
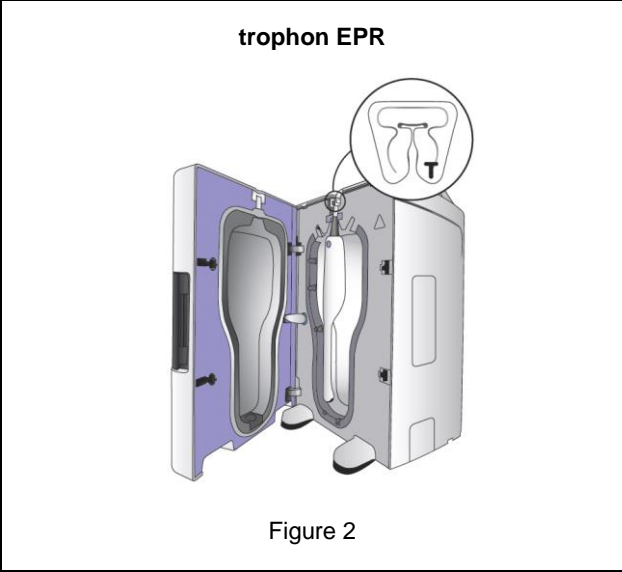

trophon®EPR und trophon2

## Liste der kompatiblen Ultraschallsonden

Die Sonden auf dieser Liste wurden nach umfangreichen Kompatibilitätsprüfungen, die in Zusammenarbeit mit den Erstausrüstern (OEMs) durchgeführt wurden, für den Gebrauch mit dem trophon® EPR bzw. dem trophon®2 zugelassen. Abbildung 1 zeigt das rigorose Kompatibilitätsprogramm von Nanosonics für Sonden.



Abbildung 1

**Die Liste der kompatiblen Ultraschallsonden von trophon EPR und trophon2 enthält ausschließlich Sonden, deren Kompatibilität von einem OEM und Nanosonics gemeinsam genehmigt und bestätigt wurde.**

Zugelassene Sonden sind nach Hersteller, Serien (Series) (falls zutreffend) und dann Modellnummer (Model) in den nachstehenden Tabellen aufgeführt.

Stellen Sie sicher, dass Ihre Sonde mit dem trophon EPR bzw. dem trophon2 kompatibel ist. Die Kompatibilität wird durch das Symbol '✓' in der entsprechenden Tabellenspalte bestätigt.

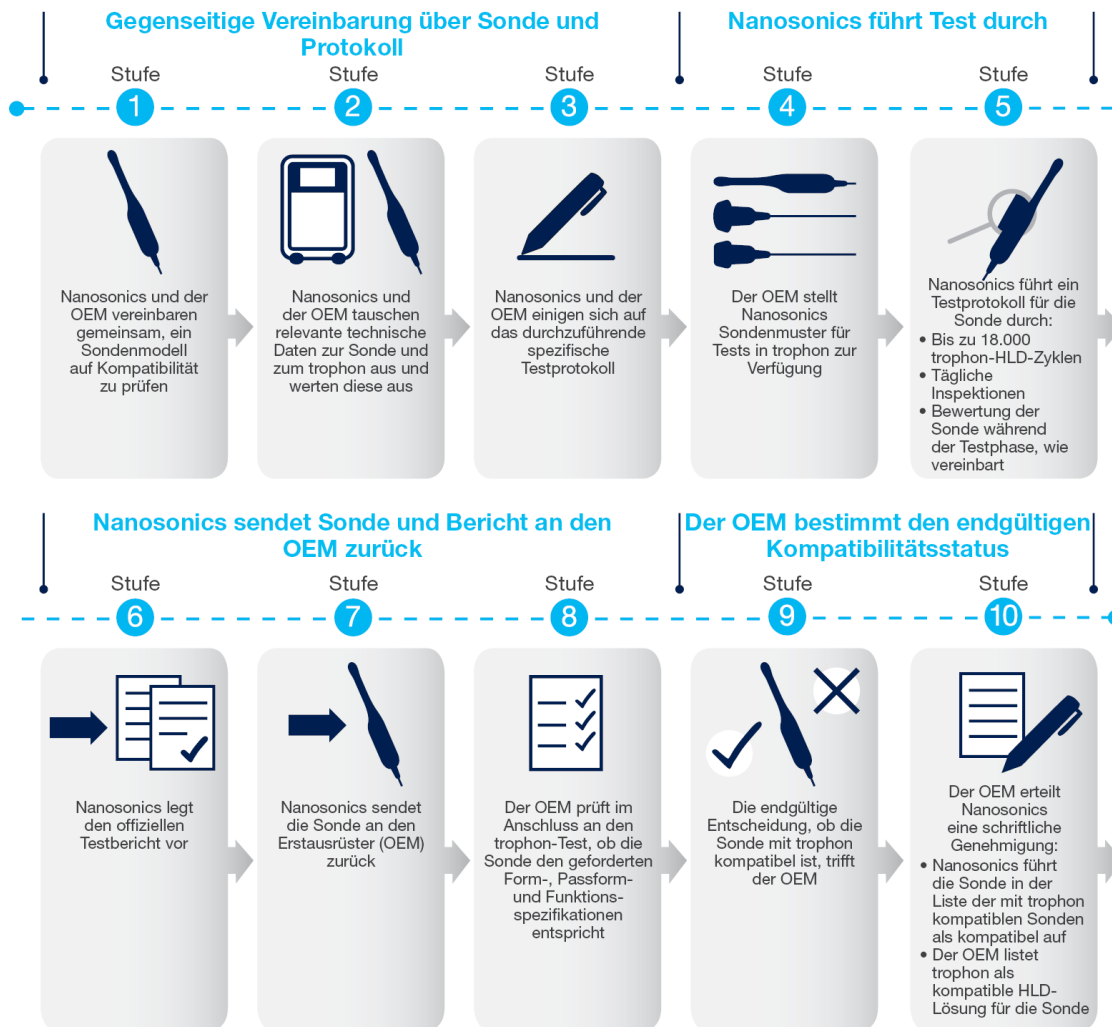
**Hinweis:** In der Gebrauchsanweisung des Sondenherstellers finden Sie Informationen über den Aufbereitungsgrad, der je nach klinischem Anwendungsfall der Sonde erforderlich ist. Bei Sonden, die für die abschließende Aufbereitung sterilisiert werden müssen, kann als Zwischenschritt eine hochwirksame Desinfektion (HLD=High Level Disinfection) angewandt werden, um die Keimbelastung vor der Sterilisation zu reduzieren. Wenn eine Sonde sterilisiert werden muss, eine Sterilisation aber nicht möglich ist, kann die hochwirksame Desinfektion (HLD) der Sonde in Verbindung mit der Verwendung einer sterilen Hülle in Betracht gezogen werden.

### **Besondere Bedingungen:**

Für mit Symbolen gekennzeichnete Modelltypen gelten besondere Bedingungen bei der Verwendung mit dem trophon EPR bzw. dem trophon2.

Bitte beachten Sie diese besonderen Bedingungen bei der Verwendung dieser Sonden.

- <sup>1</sup> Prosonic (L5-10/40EPN): Nur Sonden, die nach dem 30. Dezember 2011 hergestellt wurden, sind kompatibel.
- <sup>2</sup> Ultrasonix (L14-5/38): Nur Sonden mit Seriennummern vom Format TRA1.1-L145RP.xxx sind kompatibel. Fragen Sie im Zweifelsfall Ihren Ansprechpartner bei Ultrasonix.
- <sup>3</sup> Hitachi Aloka Medical: Wenn die Seriennummer in der Liste mit Klammern angegeben ist, z. B. (M00621~), sind nur Sonden mit diesen Seriennummern für dieses Sondenmodell geeignet.
- <sup>4</sup> Diese Sonden enthalten Lumen, die in trophon EPR/trophon2 nicht hochwirksam desinfiziert werden können. Informationen zur Desinfektion der Lumen finden Sie in den Aufbereitungshinweisen in der Gebrauchsanweisung des Originalgeräteherstellers der Sonden. In den USA, Kanada und Japan kann trophon EPR/trophon2 nur zur hochwirksamen Desinfektion der Außenflächen dieser Sonden verwendet werden.
- <sup>5</sup> EchoNous (Kosmos Torso/Kosmos Torso – ONE): Der EMV-Entstörer muss in die Kammer unter der Kabelklammer eingesetzt werden
- <sup>6</sup> Siemens Freestyle – Kabellose Sonden: Die Batterie muss vor der Desinfektion entfernt werden.
- **CPP** Der trophon CPP (Curved Probe Positioner, Positionierer für Konvexsonden) kommt im trophon EPR zum Einsatz, um die Positionierung zugelassener Konvexsonden in der Gerätekammer zu optimieren. Weitere Informationen zur Installation und Verwendung finden Sie in der Gebrauchsanweisung des trophon CPP.

**Hinweis:** Das trophon CPP ist für das trophon2 NICHT erforderlich.

- <sup>T</sup> Die trophon EPR T-Klammer (siehe Abbildung 2 unten) ist für bestimmte Ultraschallsondenkabel erhältlich. Bitte kontaktieren Sie Ihren trophon EPR-Vertreter für weitere Informationen oder fordern Sie eine T-Klammer an.

**Hinweis:** Eine T-Klammer ist für das trophon2 NICHT erforderlich.

- **IPP** Der Integrierte Sondenpositionierer (IPP=Integrated Probe Positioner) von trophon2 ist ein vollständig in das trophon2 integrierter Mechanismus (siehe Abbildung 3 unten), der die Positionierung aller zugelassenen gebogenen Sonden in der trophon2-Klammer verbessert. Informationen zur Verwendung des IPP finden Sie in der Gebrauchsanweisung des trophon2.
- **WUPH-A** trophon Wireless Ultrasound Probe Holder-A (WUPH-A) hält eine kompatible drahtlose Ultraschallsonde in der trophon-Kammer. Er kann mit mit trophon EPR- und trophon2-Geräten verwendet werden (siehe Abbildung 4 bzw. Abbildung 5).

**Hinweis:** Der trophon WUPH-A ist in ausgewählten Märkten erhältlich. Wenden Sie sich für weitere Informationen an einen Nanosonics-Vertreter.

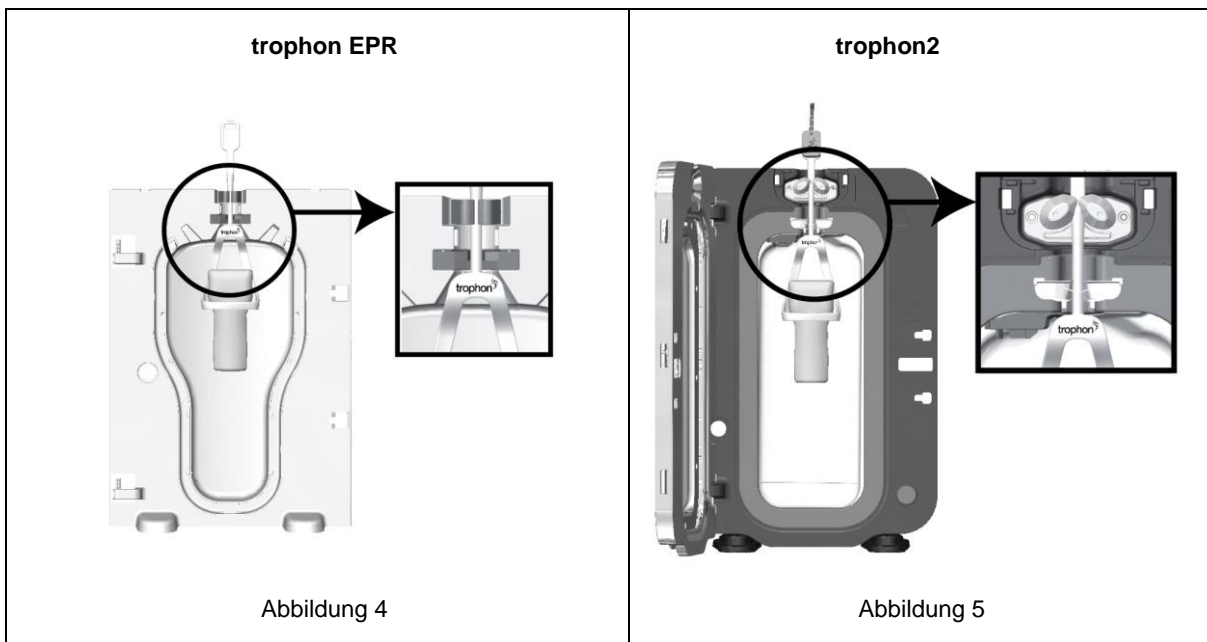
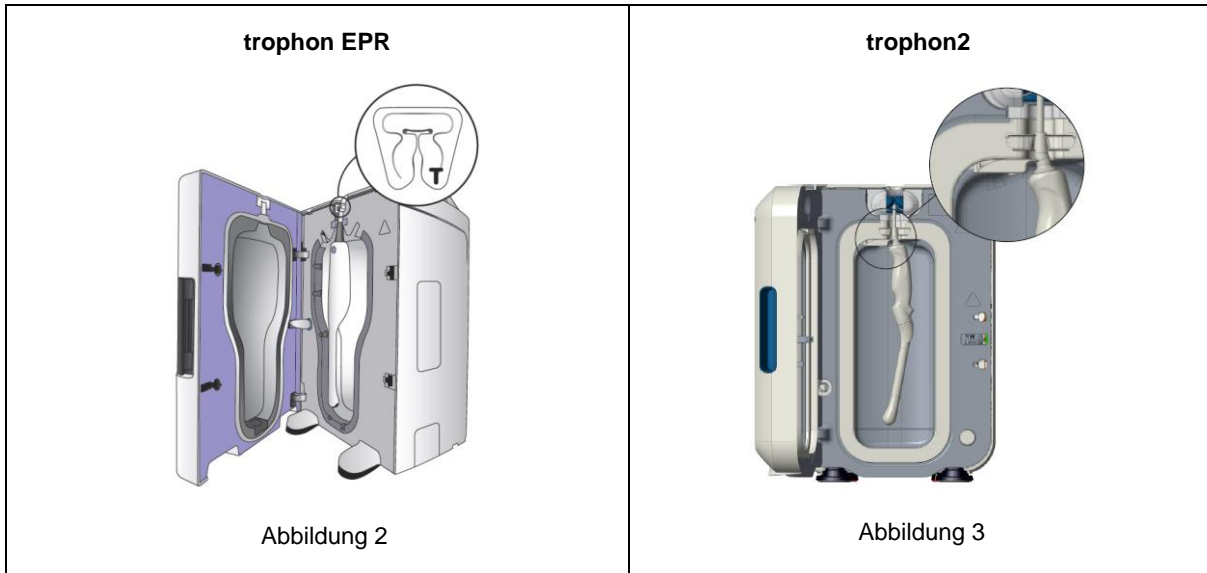

trophon® EPR et trophon2®

## Liste des sondes à ultrasons compatibles

L'utilisation des sondes répertoriées dans cette liste avec le trophon® EPR et le trophon2® a été autorisée au terme d'une vaste série de tests de compatibilité réalisés en collaboration avec les fabricants d'origine (FEO) des sondes. La figure 1 illustre le programme rigoureux de compatibilité des sondes de Nanosonics.

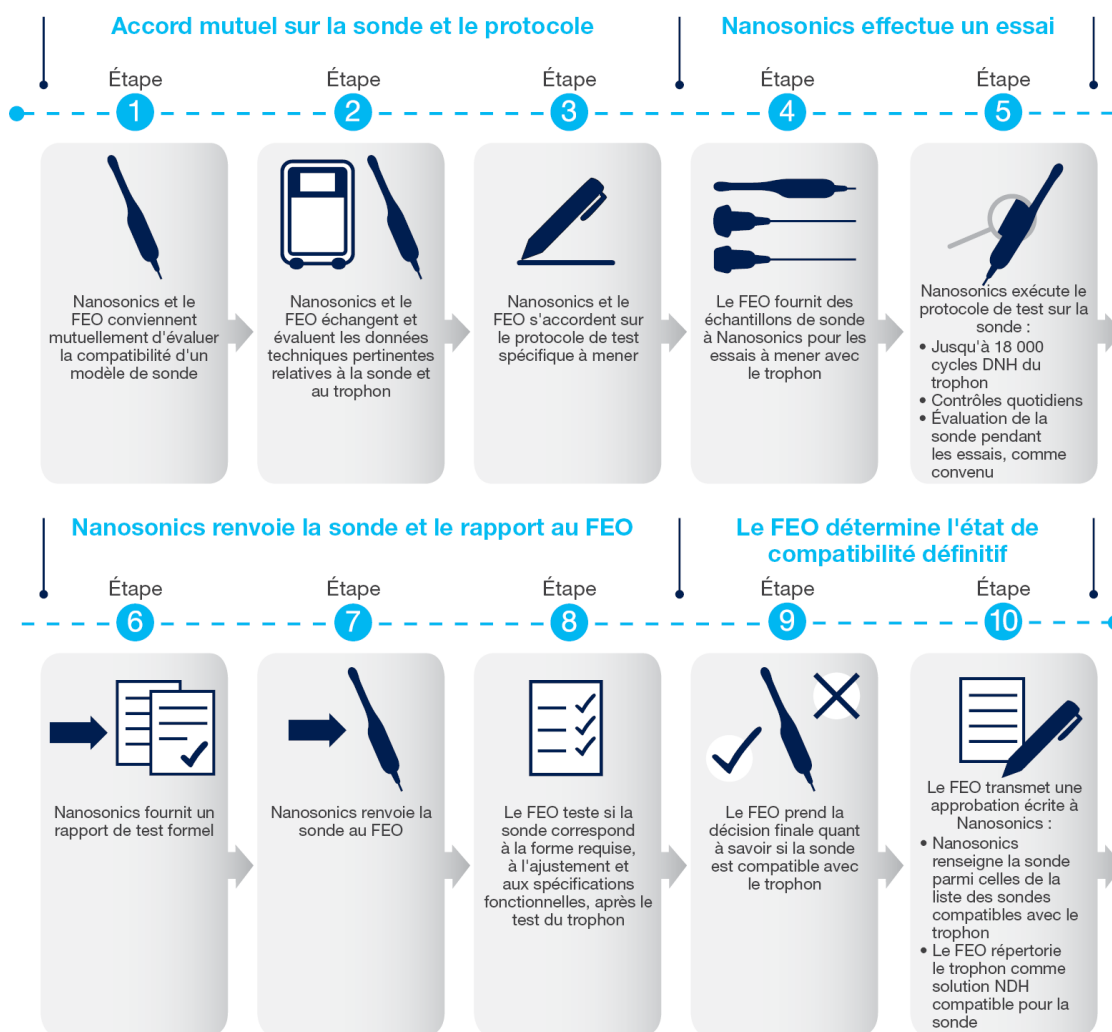

Figure 1

**Seules les sondes qui ont été conjointement approuvées et avalisées pour leur compatibilité par un FEO et Nanosonics sont ajoutées à la liste des sondes à ultrasons compatibles avec le trophon EPR et le trophon2.**

Les sondes autorisées sont répertoriées par fabricant, par série (Series), le cas échéant, et par modèle (Model) dans les tableaux suivants.

Veuillez vérifier la compatibilité de votre/vos sonde(s) avec les appareils trophon EPR et trophon2, indiquée par '✓' dans leur colonne respective du tableau.

**Remarque :** Reportez-vous aux consignes d'utilisation (IFU) du fabricant de la sonde pour obtenir des informations sur le niveau de retraitement requis en fonction du cas d'utilisation clinique de la sonde. Une désinfection de haut niveau (DHN) est ainsi recommandée, en guise d'étape intermédiaire, en ce qui concerne les sondes nécessitant une stérilisation pour le retraitement final, afin de réduire la charge microbienne avant la stérilisation. Dans certains cas où une sonde nécessite une stérilisation, mais que cette dernière n'est pas possible, la DHN de la sonde et l'utilisation avec une gaine stérile peuvent être envisagées.

### Conditions spéciales :

Les modèles comportant des symboles en regard de leur nom sont associés à des conditions d'utilisation spécifiques lorsqu'ils sont utilisés avec le trophon EPR et le trophon2.

Veuillez vous familiariser avec ces conditions d'utilisation lorsque vous utilisez ces sondes.

- <sup>1</sup> Prosonic (L5-10/40EPN) : seules les sondes fabriquées après le 30 décembre 2011 sont compatibles.
- <sup>2</sup> Ultrasonix (L14-5/38) : seules les sondes dont le format de numéro de série est TRA1.1-L145RP.xxx sont compatibles. En cas de doutes, demandez confirmation à votre représentant Ultrasonix.
- <sup>3</sup> Hitachi Aloka Medical : lorsque le numéro de série indiqué dans la liste figure entre parenthèses, par ex. (M00621~), seules les sondes de ce modèle portant ces numéros de série sont compatibles.
- <sup>4</sup> Ces sondes contiennent des lumens qui ne peuvent pas faire l'objet d'une désinfection de haut niveau pour le trophon EPR et le trophon2. Pour la méthode de désinfection des lumens, veuillez consulter le mode d'emploi du fabricant d'équipement d'origine de la sonde. Aux États-Unis, au Canada et au Japon, le trophon EPR et le trophon2 peuvent être utilisés pour effectuer une désinfection de haut niveau des surfaces externes de ces sondes uniquement.
- <sup>5</sup> EchoNous (Kosmos Torso/Kosmos Torso – ONE) : le supprimeur CEM doit être placé à l'intérieur de la chambre, sous le pince-câble.
- <sup>6</sup> Portée de la sonde sans fil Siemens Freestyle : la batterie doit être retirée avant la désinfection.
- **CPP** Le trophon CPP (de l'acronyme anglais pour Curved Probe Positioner, « positionneur de sonde convexe ») est un accessoire du trophon EPR qui sert à améliorer le positionnement des sondes convexes homologuées dans la chambre de l'appareil. Reportez-vous aux consignes d'utilisation du trophon CPP pour plus d'informations sur sa configuration et son utilisation.

**Remarque** : le trophon CPP n'est PAS requis pour le trophon2.

- <sup>T</sup> La pince T-Clamp du trophon EPR (voir Figure 2 ci-dessous) est disponible pour les câbles de sonde à ultrasons désignés. Veuillez contacter votre représentant trophon EPR pour plus de renseignements ou pour demander une pince T-Clamp.

**Remarque** : la pince T-Clamp n'est PAS requise pour le trophon2.

- **IPP** Le guide intégré de mise en place de la sonde (GIS) du trophon2 est un mécanisme entièrement intégré au trophon2 (voir la Figure 3 ci-dessous) qui améliore le positionnement de toutes les sondes convexes homologuées dans la chambre du trophon2. Pour de plus amples informations sur l'utilisation du GIS, veuillez consulter le mode d'emploi du trophon2.
- **WUPH-A** Le trophon Wireless Ultrasound Probe Holder-A (WUPH-A) contient une sonde à ultrasons sans fil compatible dans la chambre du trophon. Il peut être utilisé avec les appareils trophon EPR et trophon2 (voir Figure 4 et Figure 5 respectivement).

**Remarque** : Le trophon WUPH-A est disponible sur certains marchés. Contactez un représentant Nanosonics pour plus d'informations.



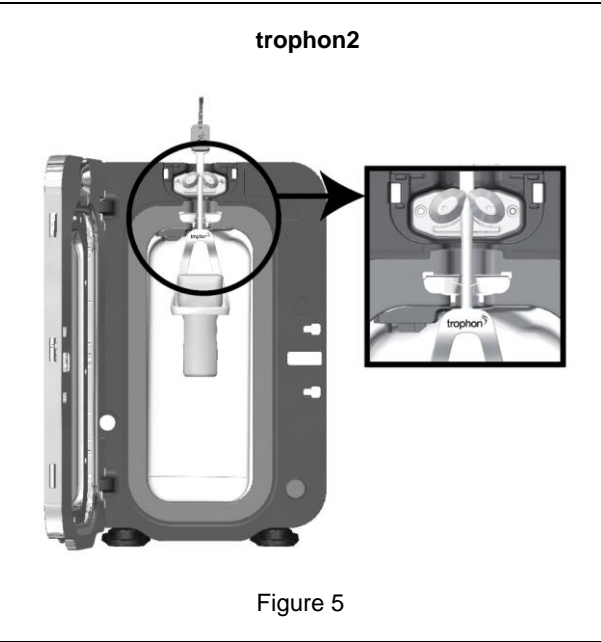
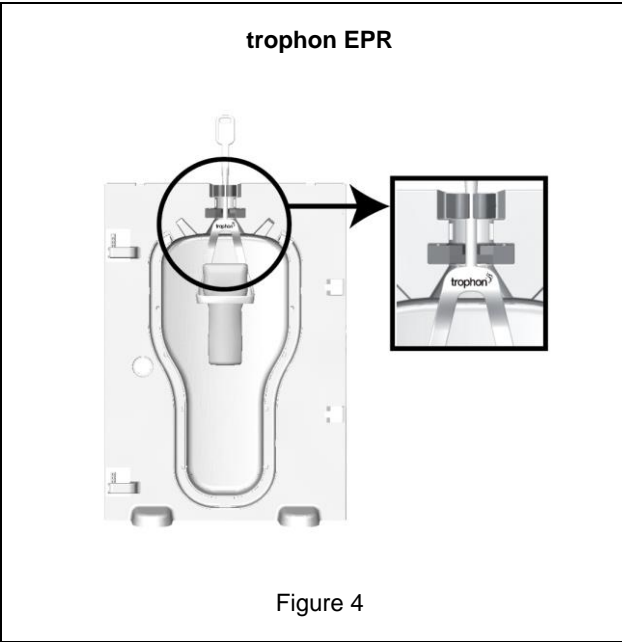
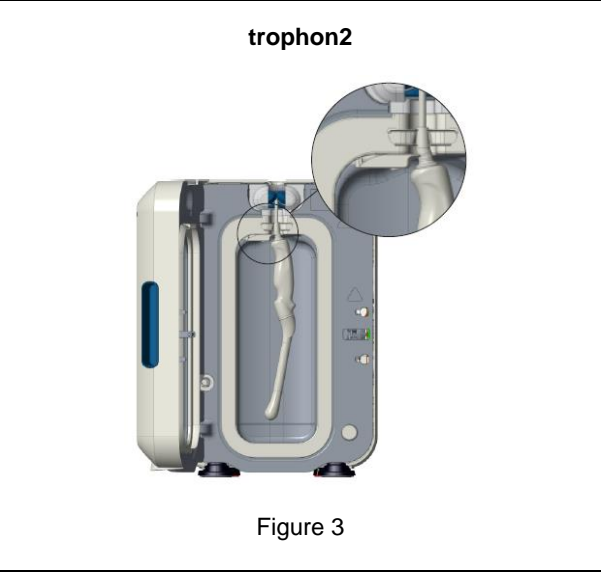
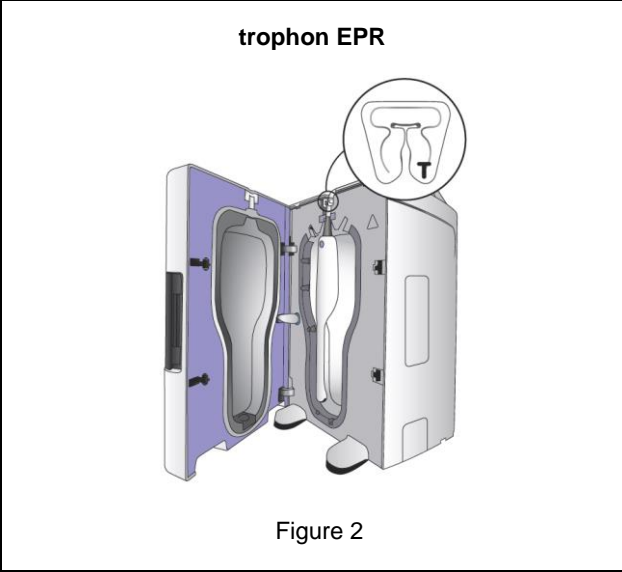

trophon® EPR en trophon2®

## Lijst van compatibele echoscopiesondes

De sondes in deze lijst zijn goedgekeurd voor gebruik met de trophon® EPR en/of trophon2®, op basis van uitgebreide compatibiliteitstesten die in samenwerking met de OEM's (Original Equipment Manufacturers - oorspronkelijke fabrikanten van de apparatuur) van de sondes zijn uitgevoerd. Figuur 1 toont het rigoureuze compatibiliteitsprogramma voor sondes van Nanosonics.

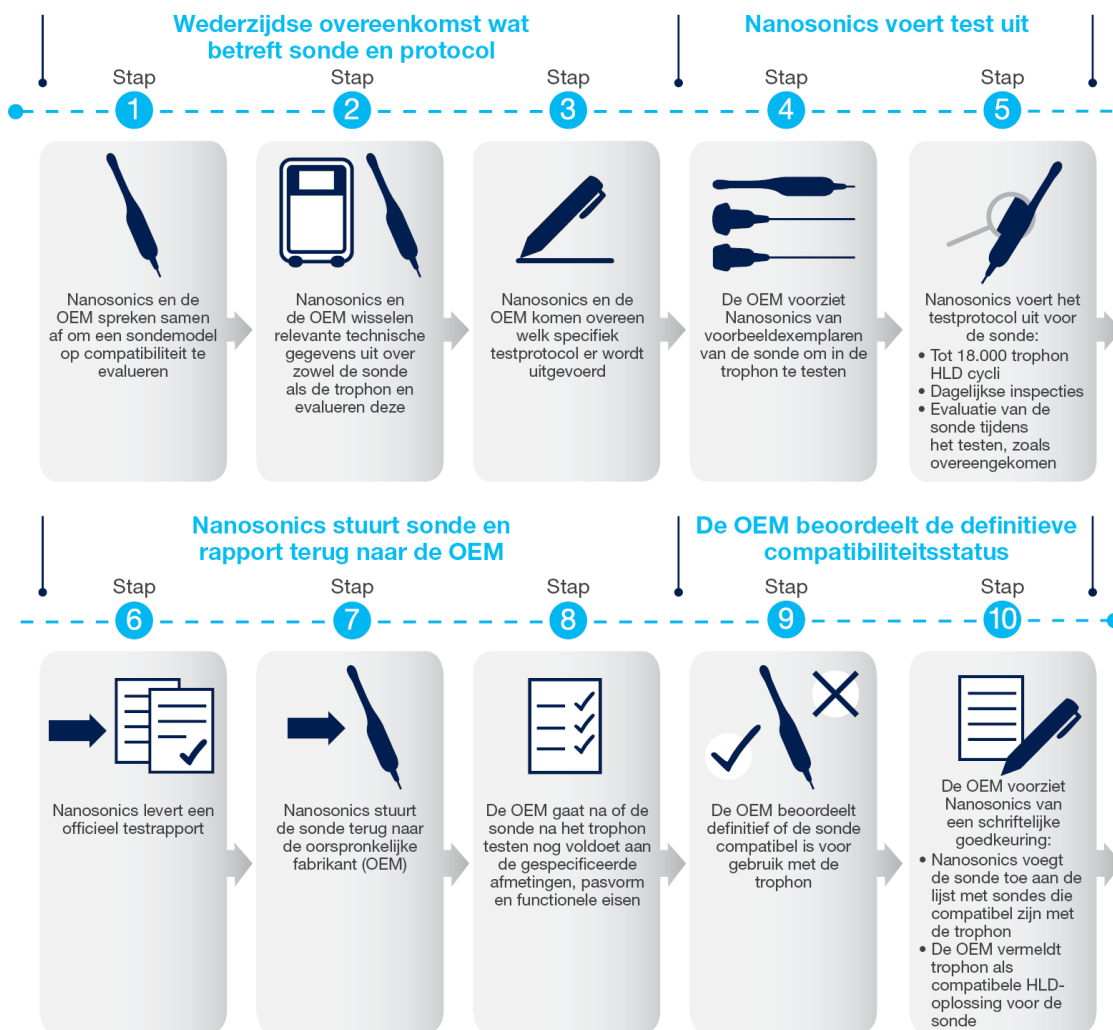

Figuur 1

**De lijst van compatibele echoscopiesondes voor de trophon EPR en trophon2 bevat alleen sondes die door zowel de oorspronkelijke fabrikant als Nanosonics goedgekeurd en als geschikt bevestigd zijn.**

In de onderstaande tabellen worden de goedgekeurde sondes vermeld per fabrikant, serie (Series) – indien van toepassing – en vervolgens modelnummer (Model).

Controleer of uw sonde(s) compatibel zijn met de trophon EPR of trophon2, wat wordt aangegeven met het symbool '✓' in de bijbehorende kolom van de tabel.

Let op: Zie de gebruiksaanwijzing van de fabrikant om na te gaan in hoeverre de sonde opnieuw verwerkt moet worden na klinisch gebruik van de sonde. Sondes die voor de eindverwerking sterilisatie vereisen vergen wellicht eerst desinfectie op hoog niveau (HLD) als tussenliggende stap om zo de biolading bij sterilisatie te reduceren. In voorkomende gevallen waar sterilisatie wel noodzakelijk, maar niet mogelijk is, kan HLD van de sonde en gebruik van een steriel omhulsel overwogen worden.

### **Bijzondere voorwaarden:**

Voor modeltypen die van symbolen zijn voorzien, gelden speciale voorwaarden wanneer ze in combinatie met de trophon EPR en trophon2 worden gebruikt.

Zorg ervoor dat u op de hoogte bent van deze speciale voorwaarden wanneer u deze sondes gebruikt.

- <sup>1</sup> Prosonic (L5-10/40EPN): Alleen sondes die na 30 december 2011 zijn geproduceerd zijn compatibel.
- <sup>2</sup> Ultrasonix (L14-5/38): Alleen transducers met een serienummer dat als volgt is opgebouwd: TRA1.1-L145RP.xxx, zijn compatibel. In geval van twijfel, raadpleeg uw Ultrasonix-vertegenwoordiger.
- <sup>3</sup> Hitachi Aloka Medical: Wanneer in de lijst tussen haakjes een serienummer wordt aangegeven, zoals bijvoorbeeld (M00621~), zijn voor dit sondemodel alleen sondes met een overeenkomstig serienummer compatibel.
- <sup>4</sup> Deze sondes bevatten lumens die niet op hoog niveau kunnen worden gedesinfecteerd in de trophon EPR of trophon2. Raadpleeg voor het desinfecteren van de lumens de gebruiksaanwijzing van de originele sondefabrikant. In de VS, Canada en Japan kunnen de trophon EPR en trophon2 alleen worden gebruikt voor desinfectie op hoog niveau van de externe oppervlakken van deze sondes.
- <sup>5</sup> EchoNous (Kosmos Torso/Kosmos Torso – ONE): EMC-onderdrukker wordt in de kamer geladen, onder de snoerklem.
- <sup>6</sup> Siemens Freestyle reeks draadloze sondes: Voor desinfectie altijd eerst de batterij verwijderen.
- **CPP** De trophon CPP (gebogen-sondehouder) is een accessoire voor het trophon EPR-apparaat ter ondersteuning van de plaatsing van goedgekeurde gebogen sondes in de apparaatkamer. Zie de gebruiksaanwijzing van de trophon CPP voor meer informatie over de instelling en het gebruik ervan.  
**N.B.:** De trophon CPP is NIET vereist voor de trophon2.
- **T** Een trophon EPR T-klem (zie Figuur 2 hieronder) is verkrijgbaar voor aangewezen echoscopie-sondesnoeren. Voor meer informatie of om een T-klem te bestellen, kunt u contact opnemen met uw trophon EPR-vertegenwoordiger.  
**N.B.:** De T-klem is NIET vereist voor de trophon2.
- **IPP** De geïntegreerde sondeplaatser (IPP) van de trophon2 is een volledig geïntegreerd mechanisme in de trophon2 (zie Figuur 3 hieronder) dat de plaatsing in de trophon2-kamer verbetert voor alle goedgekeurde gebogen sondes. Raadpleeg de gebruikershandleiding van de trophon2 voor informatie over het gebruik van de IPP.
- **WUPH-A** De trophon Wireless Ultrasound Probe Holder-A (WUPH-A) houdt een compatibele draadloze echoscopie-sonde in de trophon-kamer. De trophon Wireless Ultrasound Probe Holder is geschikt voor gebruik met trophon EPR- en trophon2-apparaten (zie respectievelijk Figuur 4 en Figuur 5).

**Opmerking:** de trophon WUPH-A is beschikbaar in geselecteerde markten. Neem voor meer informatie contact op met een vertegenwoordiger van Nanosonic.

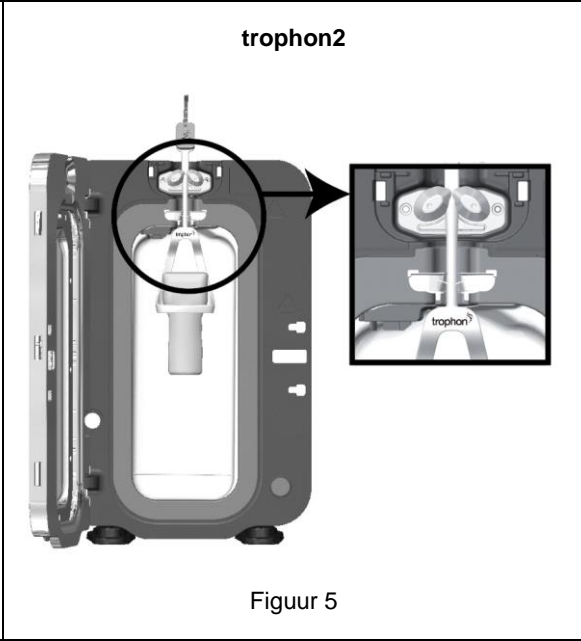
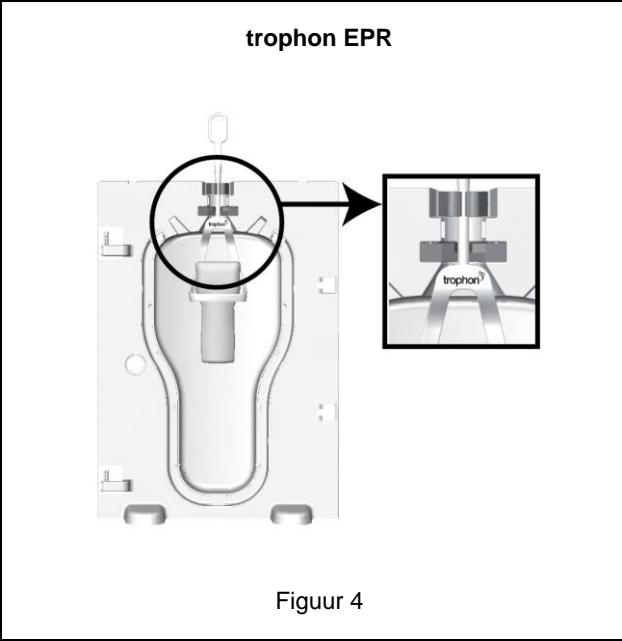
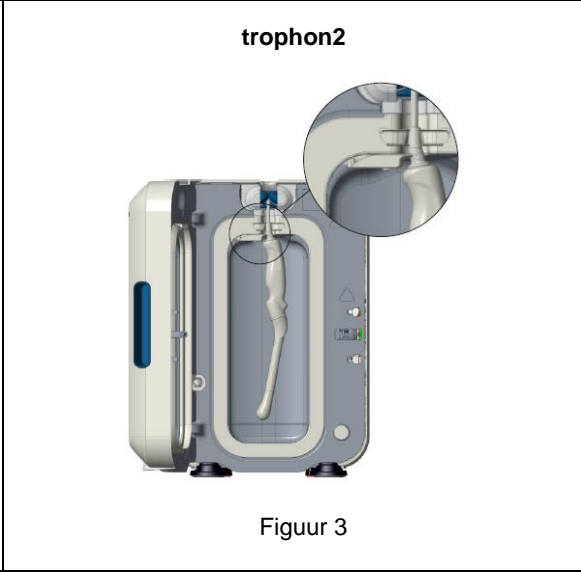
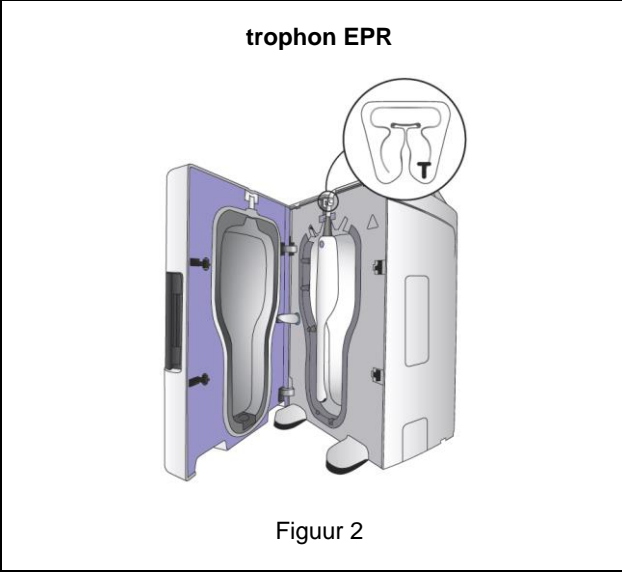

trophon® EPR e trophon2

## Elenco delle sonde a ultrasuoni compatibili

Le sonde di questo elenco sono state approvate per l'uso con i dispositivi trophon® EPR e/o trophon2 dopo rigorose prove di compatibilità eseguite in collaborazione con i produttori di materiali originali (OEM) che hanno prodotto le sonde. La Figura 1 illustra il rigoroso programma Nanosonics per accertare la compatibilità delle sonde.



Figura 1

**Solo le sonde congiuntamente approvate e dichiarate compatibili da un OEM e da Nanosonics vengono inserite nell'Elenco delle sonde a ultrasuoni compatibili con trophon EPR e trophon2.**

Le sonde approvate sono elencate nelle tabelle seguenti in ordine di produttore, serie (Series) ove pertinente e numero di modello (Model).

Verificare che le sonde in uso siano compatibili con i dispositivi trophon EPR e trophon2. La compatibilità è indicata da: '✓' nella colonna corrispondente della tabella.

**NB:** Consultare le Istruzioni per l'uso (IFU) del produttore della sonda per informazioni circa il grado di ritrattamento richiesto dopo l'utilizzo clinico della sonda. Le sonde che richiedono la sterilizzazione per il ritrattamento terminale potrebbero necessitare della Disinfezione ad alto livello (HLD) come passaggio intermedio, allo scopo di ridurre la carica microbica prima della sterilizzazione. Nei casi in cui una sonda richieda la sterilizzazione ma quest'ultima non sia consentita, è possibile considerare la Disinfezione ad alto livello (HLD) e l'utilizzo con guaina sterile della sonda.

### Condizioni particolari:

I tipi di modelli accompagnati da simboli comportano condizioni particolari quando vengono utilizzati insieme ai dispositivi trophon EPR e trophon2.

Prestare la dovuta attenzione a tali condizioni nell'utilizzare le sonde in questione.

- <sup>1</sup> Prosonic (L5-10/40EPN): Sono compatibili solo le sonde prodotte dopo il 30 dicembre 2011.
- <sup>2</sup> Ultrasonix (L14-5/38): Sono compatibili solo i trasduttori con il formato di numero seriale TRA1.1-L145RP.xxx. In caso di dubbi, rivolgersi al proprio rappresentante Ultrasonix.
- <sup>3</sup> Hitachi Aloka Medical: Per questo modello di sonda, sono compatibili solo le sonde con i numeri seriali indicati tra parentesi, ad esempio (M00621~).
- <sup>4</sup> I lumi di queste sonde non sono compatibili con la Disinfezione ad alto livello tramite trophon EPR o trophon2. Per la disinfezione dei lumi, consultare le Istruzioni per l'uso dei produttori di materiali originali della sonda per informazioni sul ritrattamento. Negli Stati Uniti, in Canada e in Giappone, trophon EPR e trophon2 possono essere utilizzati solo per la Disinfezione ad alto livello delle superfici esterne di queste sonde.
- <sup>5</sup> EchoNous (Kosmos Torso / Kosmos Torso – ONE): il soppressore EMC deve essere inserito nella camera, sotto il morsetto fermacavi.
- <sup>6</sup> Gamma di sonde wireless Siemens Freestyle: rimuovere la batteria prima della disinfezione.
- **CPP** trophon CPP (Curved Probe Positioner, posizionatore per sonde convesse) è un accessorio del dispositivo trophon EPR studiato per agevolare il posizionamento delle sonde convesse approvate nella camera del dispositivo. Consultare le Istruzioni per l'uso di trophon CPP per maggiori informazioni sulla preparazione e l'uso.  
**NB:** trophon CPP NON è necessario per il dispositivo trophon2.
- **T** Il morsetto a T di trophon EPR (vedi Figura 2 sottostante) è disponibile per i cavi di sonde a ultrasuoni identificati. Rivolgersi al proprio rappresentante trophon EPR per maggiori informazioni o per richiedere un morsetto a T.  
**Nota:** Il morsetto a T non è necessario per il dispositivo trophon2.
- **IPP** Il Posizionatore integrato della sonda (IPP) di trophon2 è un meccanismo totalmente integrato nel dispositivo trophon2 (vedere la Figura 3 sottostante) che migliora il posizionamento di tutte le sonde convesse approvate nella camera di trophon2. Consultare il Manuale per l'utente di trophon2 per informazioni su come utilizzare il Posizionatore integrato della sonda (IPP).
- **WUPH-A** Il trophon Wireless Ultrasound Probe Holder-A (WUPH-A) contiene una sonda a ultrasuoni wireless compatibile nella camera trophon. È idoneo all'uso con i dispositivi trophon EPR e trophon2 (vedere rispettivamente Figura 4 e Figura 5).  
**Nota:** Il trophon WUPH-A è disponibile in mercati specifici. Per ulteriori informazioni contattare un rappresentante Nanosonics.

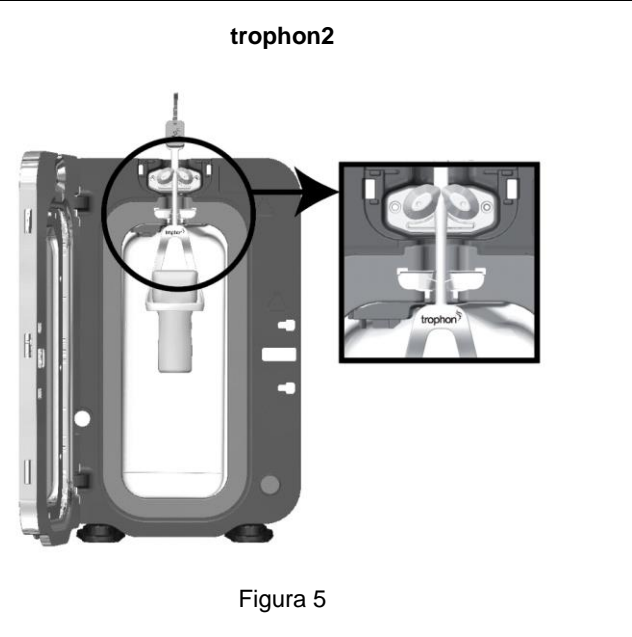
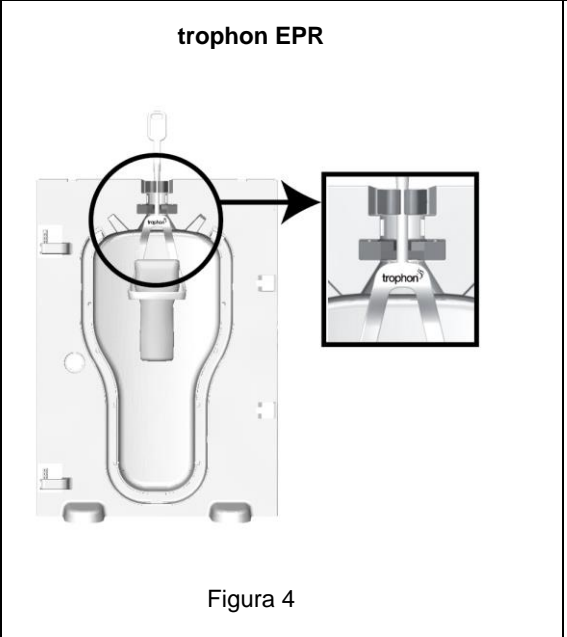
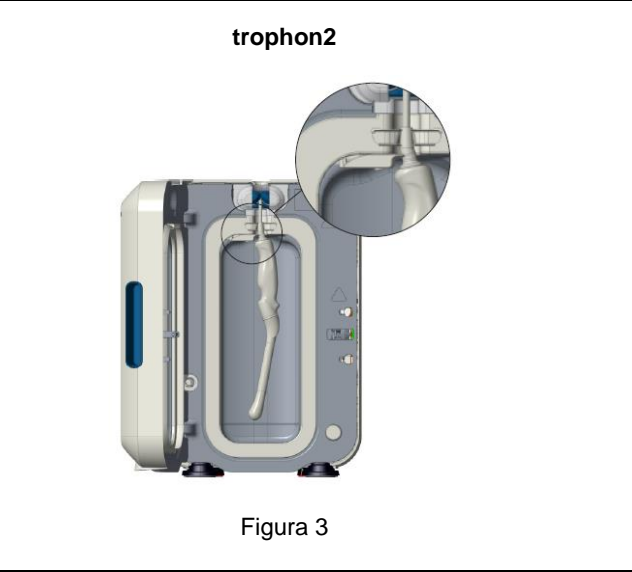
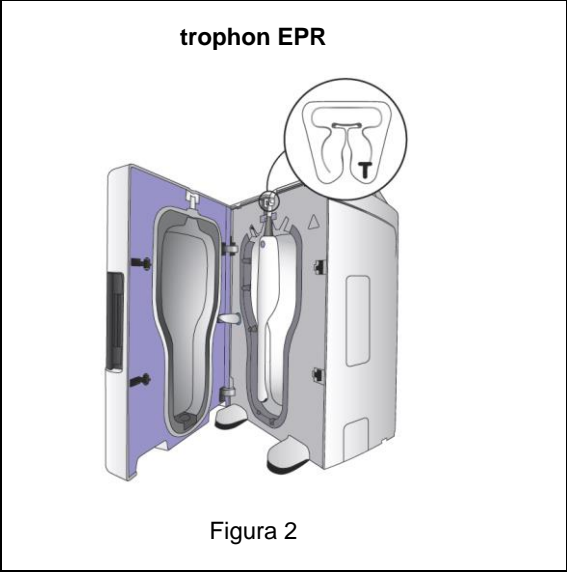

trophon® EPR y trophon2®

## Lista de sondas de ultrasonidos compatibles

Las sondas de este listado han sido aprobadas para ser empleadas en los dispositivos trophon® EPR o trophon®2 tras haberse realizado exhaustivas pruebas de compatibilidad con la colaboración de los fabricantes de los equipos originales (OEM). La Ilustración 1 muestra el estricto programa de compatibilidad de las sondas.



Ilustración 1

**Solo aquellas sondas cuya compatibilidad ha sido aprobada y respaldada conjuntamente por un OEM y Nanosonics se añaden a la Lista de sondas de ultrasonidos compatibles con trophon EPR y trophon2.**

En las tablas expuestas a continuación aparecen las sondas aprobadas agrupadas por fabricante, serie (Series), si procede, y seguidamente el número de modelo (Model).

Compruebe la compatibilidad de la sonda o sondas con los dispositivos trophon EPR y trophon2 mediante el símbolo «✓» en la columna relevante de la tabla.



**Nota:** Consulte las Instrucciones de uso (IFU) del fabricante de la sonda para obtener información sobre el nivel de procesamiento necesario después del uso clínico de la sonda. Las sondas que requieran esterilización para el reprocesamiento del terminal pueden utilizar desinfección de alto nivel (HLD) como paso intermedio para reducir la carga biológica antes de la esterilización. En algunos casos, cuando sea necesario esterilizar una sonda, pero no sea posible hacerlo, puede plantearse someterla a desinfección de alto nivel y utilizarla con un casquillo estéril.

### Condiciones especiales:

Los modelos acompañados de símbolos presentan condiciones especiales cuando son utilizados con los dispositivos trophon EPR y trophon2.

Rogamos que tenga en cuenta dichas condiciones al utilizar las sondas en cuestión.

- <sup>1</sup> Prosonic (L5-10/40EPN): solo son compatibles las sondas fabricadas después del 30 de diciembre de 2011.
- <sup>2</sup> Ultrasonix (L14-5/38): solo los transductores que tengan un número de serie con formato TRA1.1-L145RP.xxx son compatibles. Si no está seguro, consulte al representante de Ultrasonix.
- <sup>3</sup> Hitachi Aloka Medical: si el número de serie aparece en el listado entre paréntesis, p. ej. (M00621~), significa que solo las sondas que lo lleven podrán utilizarse con este modelo de sonda.
- <sup>4</sup> Estas sondas contienen luces que no pueden someterse a una desinfección de alto nivel en los dispositivos trophon EPR o trophon2. Para desinfectar las luces, consulte el apartado con información sobre el reprocesado de las instrucciones de empleo del fabricante del equipo original. En Estados Unidos, Canadá y Japón, se puede utilizar los dispositivos trophon EPR y trophon2 para someter solamente estas sondas a una desinfección de alto nivel para desinfectar las superficies externas.
- <sup>5</sup> EchoNous (Kosmos Torso/Kosmos Torso – ONE): el supresor EMC deberá cargarse en la cámara, debajo de la abrazadera del cable.
- <sup>6</sup> Gama de sondas inalámbricas Siemens Freestyle: hay que retirar la batería antes de desinfectar.
- **CPP** El CPP de trophon (posicionador de sonda curvada, CPP por sus siglas en inglés) es un accesorio para el dispositivo trophon EPR que sirve para mejorar el posicionamiento de sondas curvadas aprobadas dentro de la cámara del aparato. Consulte las instrucciones de empleo (IFU) del CPP trophon para obtener más información sobre su instalación y el uso.

**Nota:** NO se requiere trophon CPP para el dispositivo trophon2.

- <sup>T</sup> La abrazadera T-Clamp de trophon EPR (consulte la Figura 2 más abajo) está disponible para cables de sonda de ultrasonidos identificados. Póngase en contacto con su representante de trophon EPR si desea obtener más información o solicitar una abrazadera T-Clamp.

**Nota:** NO se requiere abrazadera T-Clamp para el dispositivo trophon2.

- **PSI** El posicionador de sonda integrado (PSI) es un mecanismo totalmente integrado en el dispositivo trophon2 (consulte la Figura 3 más abajo) que mejora el posicionamiento de las sondas curvadas en la cámara del trophon2. Consulte el manual de usuario del trophon2 para obtener más información sobre cómo usar el IPP.
- **WUPH-A** El trophon Wireless Ultrasound Probe Holder-A (WUPH-A) contiene una sonda de ultrasonidos inalámbrica compatible en la cámara trophon. Se puede utilizar con los dispositivos trophon EPR y trophon2 (consulte la Figura 4 y la Figura 5, respectivamente).

**Nota:** El WUPH-A trophon solo está disponible en determinados mercados. Póngase en contacto con un representante de Nanosonics para obtener más información.

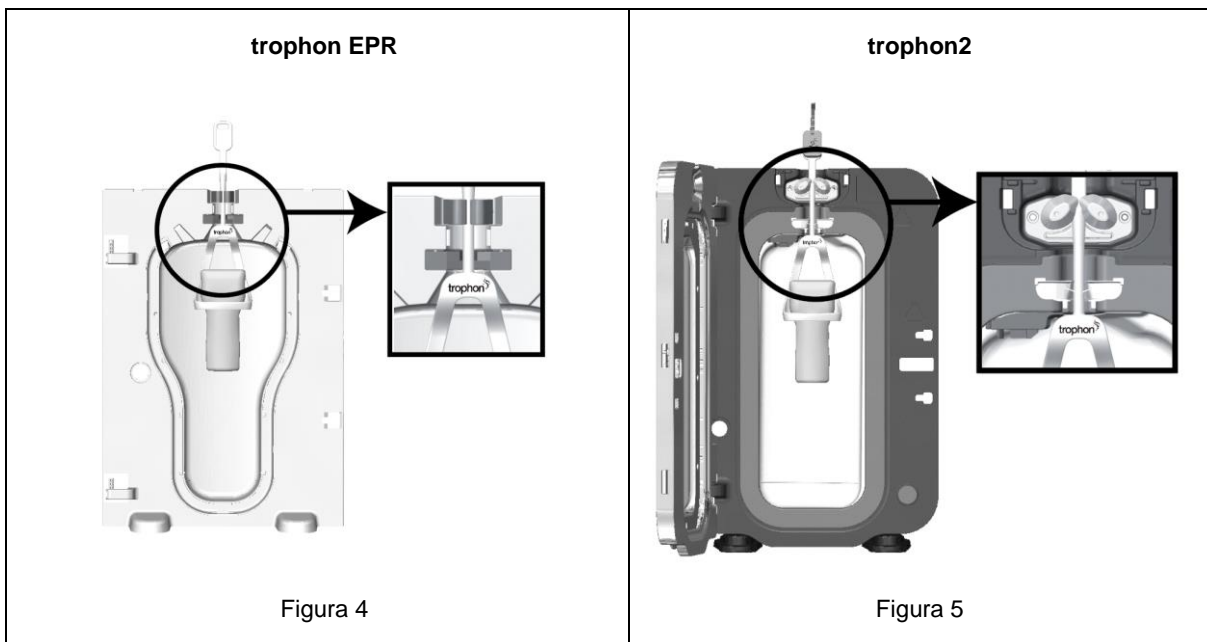
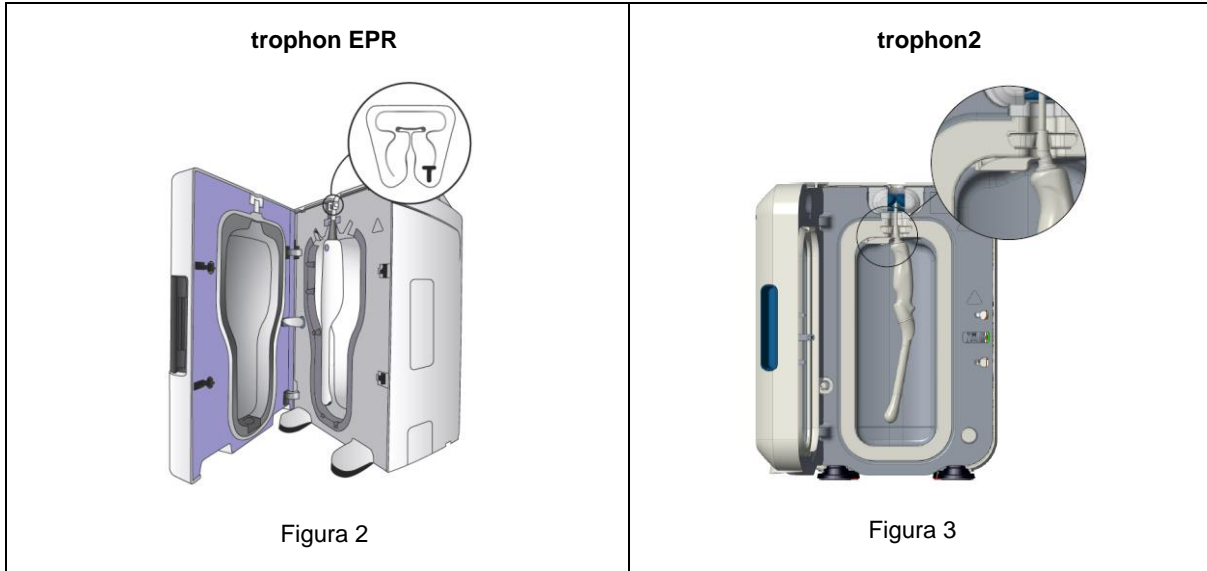

trophon® EPR og trophon2

## Liste over kompatible ultralydssonder

Sondene i denne listen er godkjent for bruk sammen med trophon® EPR og/eller trophon2 etter omfattende kompatibilitetstesting utført sammen med sondens OEM (produsent av originalutstyr). Figur 1 demonstrerer Nanosonics grundige sondekompatibilitetsprogram.

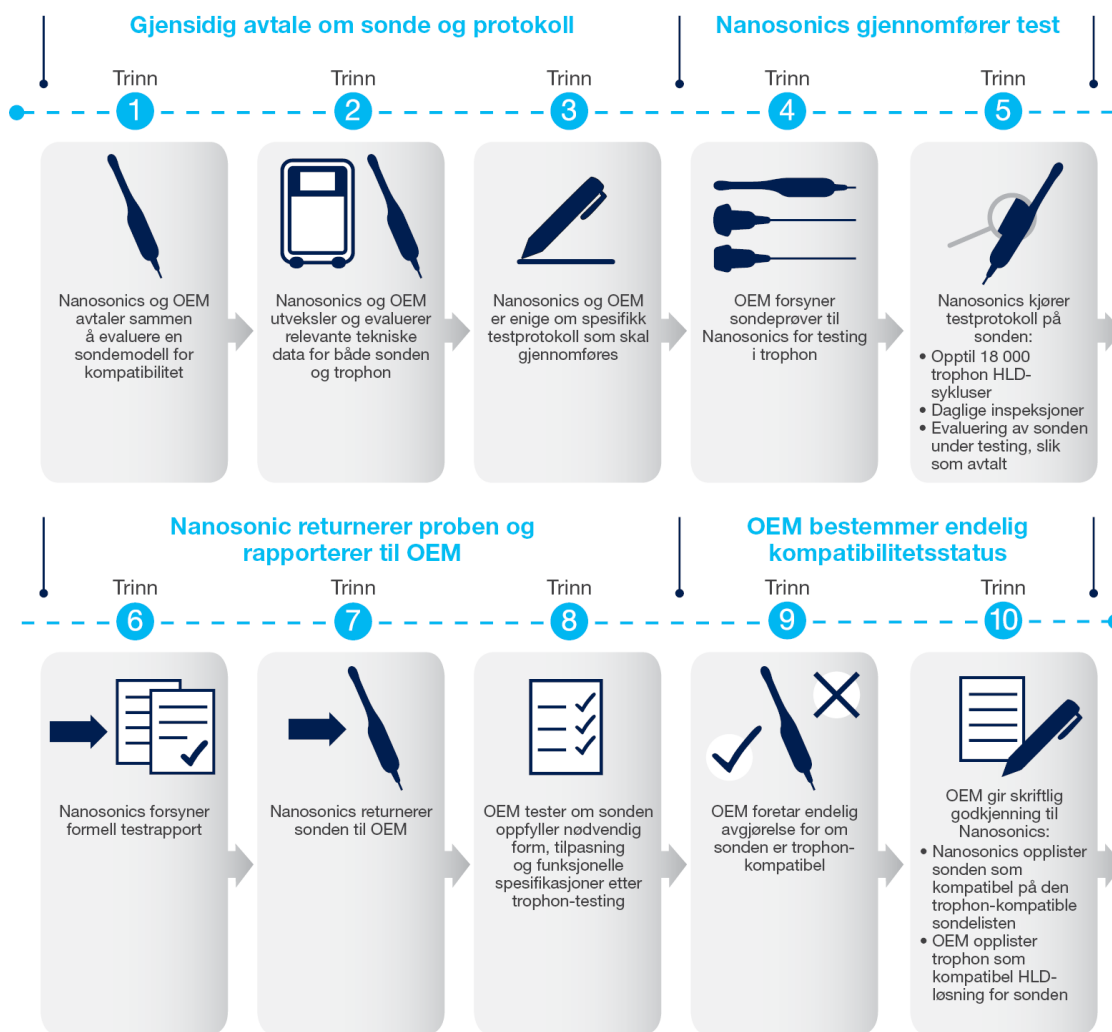

Figur 1

**Det er kun sonder som er godkjent og støttet for kompatibilitet av en OEM og Nanosonics som legges til listen for trophon EPR- og trophon2-kompatible ultralydssonder.**

Godkjente sonder er oppført etter produsent, serie (Series) og aktuelt og deretter modellnummeret (Model) i nedenstående tabell.

Kontroller sonden(e)s kompatibilitet med trophon EPR- og trophon2-enheter, indikert av: "✓" i den tilsvarende kolonnen av tabellen.

**Merk:** Se sondeprodusentens brukerinstruksjoner (IFU) for informasjon om nivået av repressering som kreves etter klinisk bruk av sonden. Sonder som krever sterilisering for terminal repressering kan bruke høyt nivå av desinfiseringsmiddel (HLD) som mellomtrinn for å redusere biologisk belastning før sterilisering. I noen tilfeller der en sonde krever sterilisering, men sterilisering ikke er mulig, kan det vurderes HLD av sonden og bruk med en steril hylse.

## Spesialbetingelser:

Modelltyper som er merket med symboler har spesialbetingelser når brukt sammen med trophon EPR- og trophon2-enheter.

Vær oppmerksom på disse spesialbetingelsene når du bruker disse sondene.

- <sup>1</sup> Prosonic (L5-10/40EPN): Kun sonder produsert etter 30. desember 2011 er kompatible.
- <sup>2</sup> Ultrasonix (L14-5/38): Kun transdusere med serienummerformatet TRA1.1-L145RP.xxx er kompatible. Hvis du er usikker, kontroller med Ultrasonix-representanten.
- <sup>3</sup> Hitachi Aloka Medical: Hvor serienummeret er spesifisert i listen med braketter, f.eks. (M00621~), er kun sonder med disse serienumrene kompatible for bruk for denne sondemodellen.
- <sup>4</sup> Disse sondene inneholder lumen som ikke kan desinfiseres på høyt nivå i trophon EPR- og trophon2-enheter. For desinfeksjon av lumen, se bruksanvisningen fra produsenten av det originale sondeutstyret for represseringsinformasjon. I USA, Canada og Japan kan trophon EPR- og trophon2-enheter kun brukes til desinfeksjon på høyt nivå av eksterne overflater på disse sondene.
- <sup>5</sup> EchoNous (Kosmos Torso/Kosmos Torso – ONE): EMC-demper skal lastes inne i kammeret, under kabelklemmen.
- <sup>6</sup> Siemens Freestyle trådløs sonde-serien: Batteriet må fjernes før desinfisering.
- **CPP** trophon CPP (buede sondeposisjonierer) er et tilbehør for trophon EPR for å støtte posisjoneringen av godkjente buede sonder i enhetskammeret. Se trophon CPP IFU for mer informasjon om oppsett og bruk.

**Merk:** trophon CPP kreves IKKE for trophon2-enheten.

- **T** trophon EPR T-klemmen (se Figur 2 under) er tilgjengelig for identifiserte sondekabler for ultralyd. Kontakt en trophon EPR-forhandler for ytterligere informasjon eller bestilling av T-klemme.

**Merk:** T-klemmen kreves IKKE for trophon2-enheten.

- **IPP** trophon2 IPP (integret sondeposisjonierer) er en fullt integrert mekanisme i trophon2-enheten (se Figur 3 nedenfor), som bedrer posisjoneringen av alle godkjente buede sonder i trophon2-kammeret. Se brukerhåndboken for trophon2 for informasjon om hvordan du bruker IPP.
- **WUPH-A** trophon Wireless Ultrasound Probe Holder-A (WUPH-A) rommer en kompatibel trådløs ultralydsonde i trophon-kammeret. Den er egnet for bruk med trophon EPR- og trophon2-enhetene (se Figur 4 og 5).

**Merk:** trophon WUPH-A er tilgjengelig i utvalgte markeder. Kontakt en Nanosonics-representant for ytterligere opplysninger.

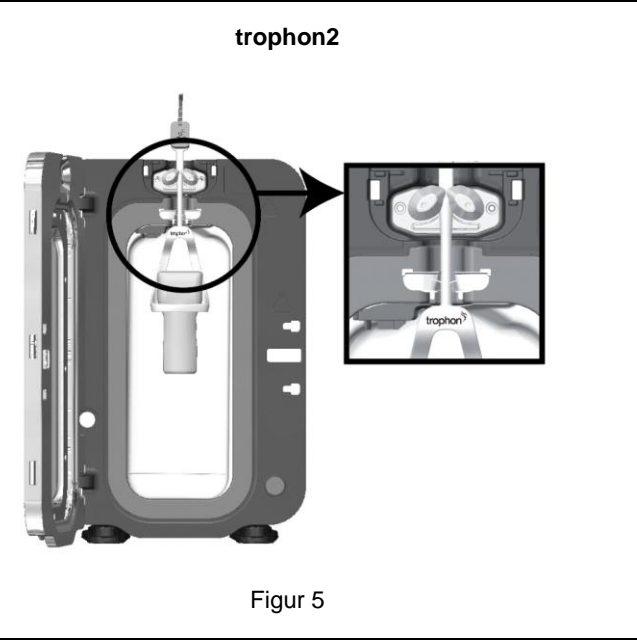
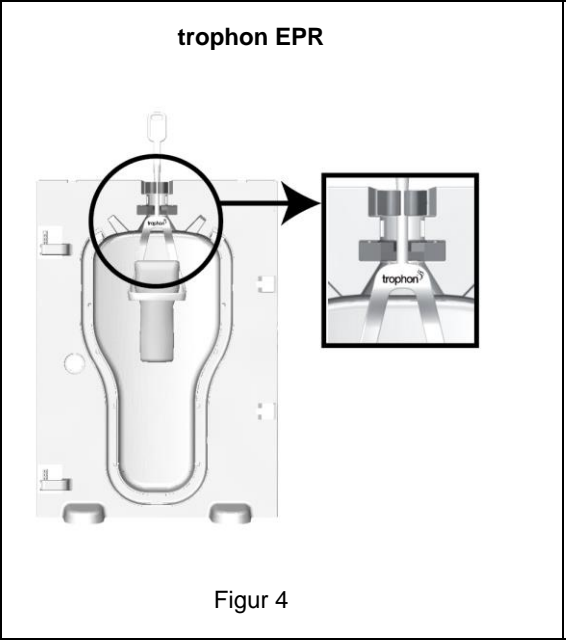
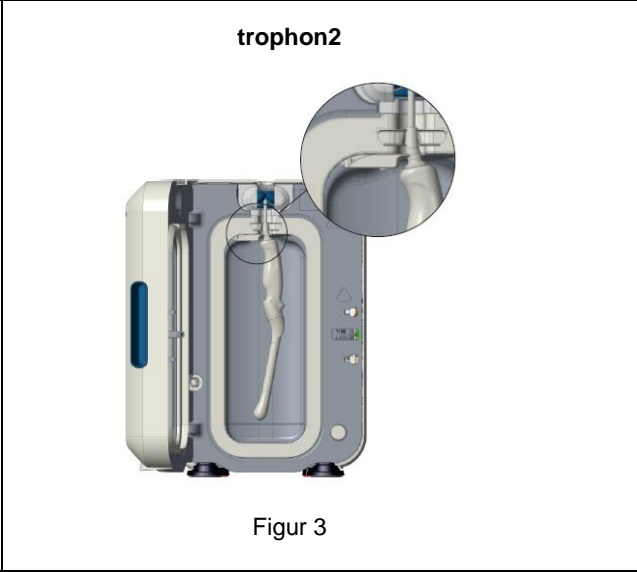
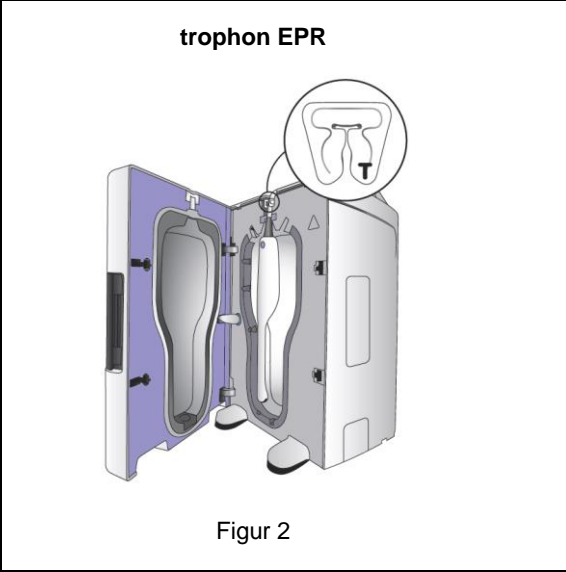

trophon® EPR ja trophon2®

## Laitteen kanssa yhteensopivien ultraääniantureiden luettelo

Tässä luettelossa olevat anturit on hyväksytty käytettäväksi trophon® EPR- ja/tai trophon2®-laitteissa alkuperäisten laitevalmistajien kanssa suoritettujen laajojen yhteensopivuustestien perusteella. Kuvassa 1 esitetään Nanosonicin vaativa yhteensopivuuohjelma.



Kuva 1

**Yhteensopivien ultraääniantureiden listaan lisätään vain trophon EPR- ja trophon2-anturit, jotka alkuperäinen laitevalmistaja ja Nanosonics ovat yhdessä hyväksyneet ja vahvistaneet yhteensopiviksi.**

Hyväksytyt anturit on lueteltu seuraavissa taulukoissa valmistajan, soveltuviissa kohdin sarjan (Series) ja mallin (Model) numeron mukaan.

Tarkista anturisi/antureidesi yhteensopivuu trophon EPR- ja trophon2-laitteiden kanssa. Yhteensopivuu osoitetaan taulukon vastaavassa sarakkeessa olevalla '✓'-merkillä.

**Huomautus:** Katso anturin valmistajan käyttöohjeista, minkä tasoista uudelleen käsittelyä anturi vaatii klinisen käytön jälkeen. Antureille, jotka on steriloitava loppukäsittelyä varten, on käytettävä korkeatasoista desinfiointia välivaiheena mikrobikuormituksen vähentämiseksi ennen sterilointia. Joissakin tapauksissa, joissa anturi vaatii sterilointia, mutta sterilointi ei ole mahdollista, voidaan harkita korkeatasoista desinfiointia ja käytön yhteydessä käytettävää steriiliä suojusta.

### Erityisiä ehtoja:

Symboleilla merkittyihin malleihin liittyy erityisiä ehtoja, kun niitä käytetään trophon EPR- ja trophon2-laitteiden kanssa.

Ota huomioon nämä erityiset ehdot kyseisiä anturimalleja käyttäessäsi.

- **1** Prosonic (L5-10/40EPN): Vain anturit, jotka on valmistettu 30. joulukuuta 2011 jälkeen, ovat yhteensopivia.
- **2** Ultrasonix (L14-5/38): Vain anturit, joiden sarjanumero on muodoltaan TRA1.1-L145RP.xxx, ovat yhteensopivia. Epävarmoissa tapauksissa on syytä tarkistaa asia Ultrasonixin edustajalta.
- **3** Hitachi Aloka Medical: Jos luettelossa oleva sarjanumero on sulkeiden sisällä, esim. (M00621~), vain kyseisillä sarjanumeroilla varustetut anturit sopivat käytettäväksi yhdessä tämän anturimallin kanssa.
- **4** Näissä antureissa on luumenit, joille ei voi tehdä korkeatasoista desinfiointia trophon2/trophon EPR -laitteessa. Katso luumeneiden desinfiointia koskevat ohjeet antureiden alkuperäisten laitevalmistajien käyttöohjeiden uudelleen käsittelyä koskevista tiedoista. Yhdysvalloissa, Kanadassa ja Japanissa trophon EPR- ja trophon2-laitteita voidaan käyttää vain näiden antureiden ulkopintojen korkeatasoiseen desinfiointiin.
- **5** EchoNous (Kosmos Torso / Kosmos Torso-ONE): EMC-suodatin on sijoitettava kammion sisäpuolelle kaapelin kiinnikkeen alapuolelle.
- **6** Langattomien Siemens Freestyle -antureiden valikoima: paristo tulee irrottaa ennen desinfiointia
- **CPP** trophon CPP (Curved Probe Positioner) -asetuslaite on trophon EPR -laitteen lisävaruste, joka auttaa asettamaan hyväksytyt kaarevat ultraäänianturit paremmin laitteen kammioon. trophon CPP -laitteen käyttöohjeissa on lisää tietoa asennuksesta ja käytöstä.

**Huomautus:** trophon2 -laitteessa EI tarvitse käyttää trophon CPP -lisävarustetta.

- **T** trophon EPR -laitteen T-kiinnike (ks. alla oleva Kuva 2) on saatavana tietyille ultraääniantureiden johdoille. Ota yhteyttä paikalliseen trophon EPR -laitteiden myyntiedustajaan, jos haluat lisätietoja tai haluat tilata T-kiinnikkeen.

**Huomautus:** trophon2 -laitteessa EI tarvitse käyttää T-kiinnikettä.

- **IPP** trophon2-laitteessa oleva anturin asetin (IPP) on trophon2-laitteeseen täysin integroitu mekanismi (ks. alla oleva Kuva 3), joka auttaa asettamaan kaikki hyväksytyt kaarevat anturit paremmin trophon2-laitteen kammioon. Katso ohjeita laitteessa olevan anturin asettimen käytöstä trophon2-käyttöohjeesta.
- **WUPH-A** trophon Wireless Ultrasound Probe Holder-A (WUPH-A) pitää yhteensopivan langattoman ultraäänianturin kiinni trophon-kammiossa. Se sopii käytettäväksi sekä trophon EPR- että trophon2-laitteiden kanssa (katso niitä vastaavat Kuvat 4 ja 5).

**Huomaa:** trophon WUPH-A on saatavana valituilla markkinoilla. Ota yhteyttä Nanosonicsin edustajaan saadaksesi lisätietoja.

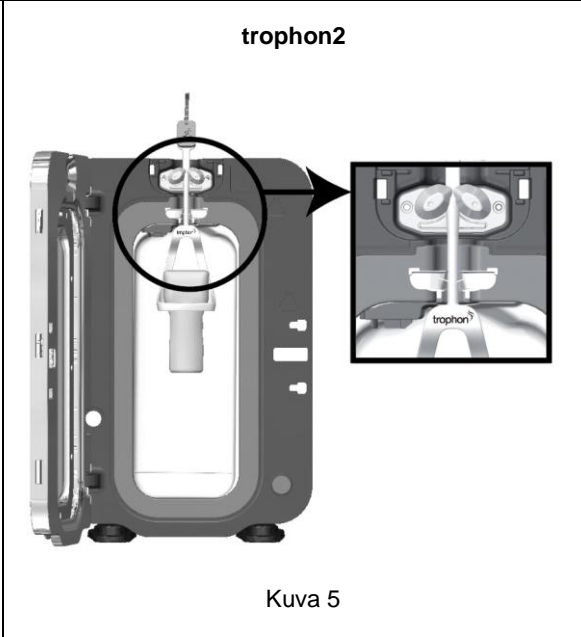
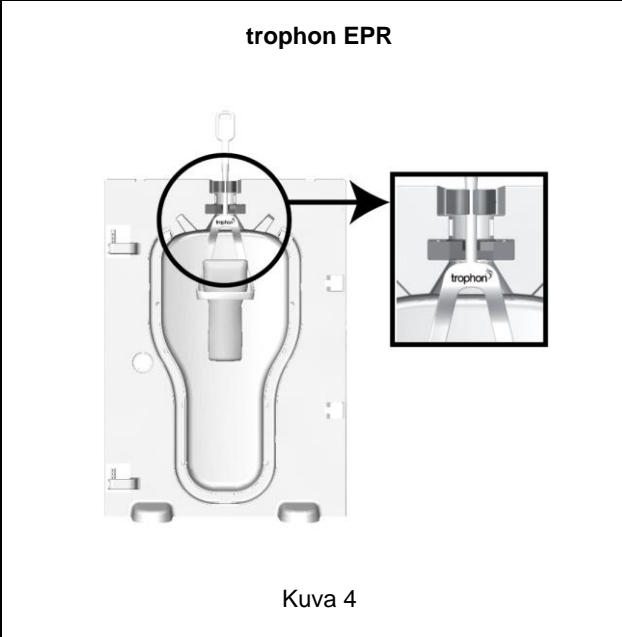
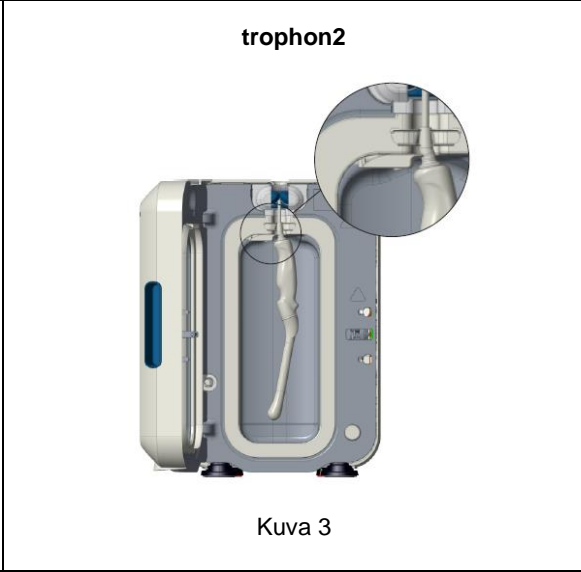
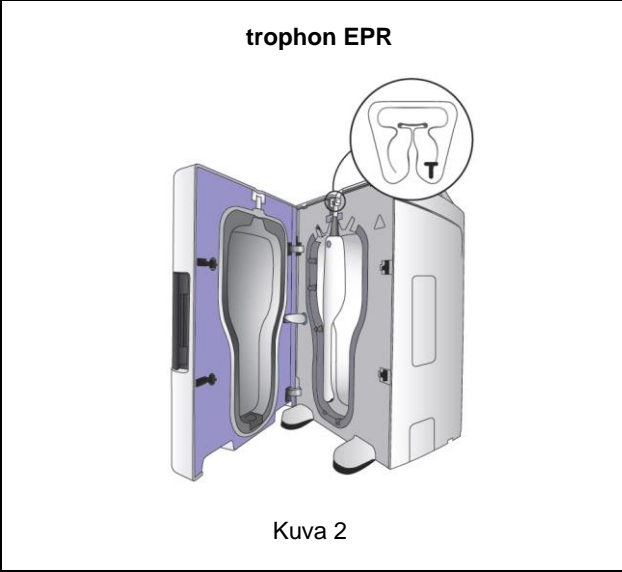



## trophon® EPR og trophon2®

### Liste over kompatible ultralydsonder

Følgende sonder er valideret til brug sammen med trophon® EPR- og/eller trophon®2-enhed(er) efter omfattende kompatibilitetstest, der er udført i samarbejde med producenterne af det originale udstyr (OEM'er). Figur 1 viser Nanosonics' strenge kompatibilitetsprogram for sonder.

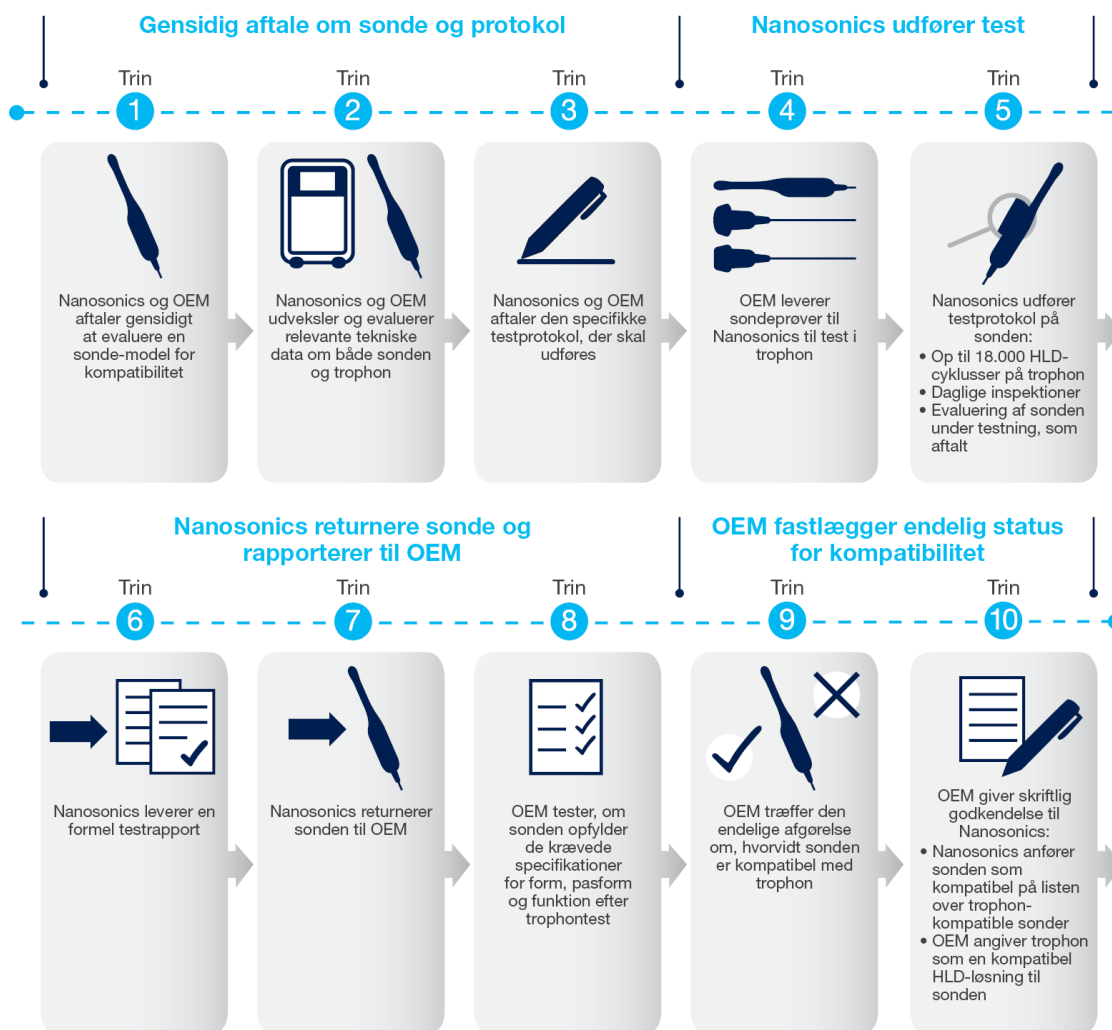

Figur 1

**Kun sonder, der er blevet godkendt og anerkendt til kompatibilitet af både en OEM og Nanosonics, føjes til listen over trophon EPR- og trophon2-kompatible ultralydssonder.**

Godkendte sonder er opført efter producent, serie (Series), hvis relevant, og derefter modelnummer (Model) i nedenstående tabeller.

Kontrollér din(e) sondes kompatibilitet med trophon EPR- og trophon2-enhederne, som er angivet ved: "✓" i den tilsvarende kolonne i tabellen.

**Bemærk:** Se sondeproducentens brugsanvisning (IFU) for at få oplysninger om det niveau af oparbejdning, der er påkrævet efter den kliniske anvendelse af sonden. Sonder, der skal steriliseres med henblik på terminal oparbejdning, kan anvende desinfektion på højt niveau (HLD) som et mellemliggende trin for at reducere biologisk belastning før sterilisering. I visse tilfælde, hvor en sonde skal steriliseres, men hvor sterilisering ikke er mulig, kan det overvejes at foretage HLD af sonden og anvende et sterilt hylster.

### Særlige betingelser:

Modeltyper mærket med symboler har særlige betingelser, når de anvendes sammen med trophon EPR- og trophon2-enheder.

Tag venligst højde for disse særlige betingelser, når disse sonder anvendes.

- <sup>1</sup> Prosonic (L5-10/40EPN): kun sonder, der er produceret efter 30. december 2011, er kompatible.
- <sup>2</sup> Ultrasonix (L14-5/38): kun transducere med serienummer i formatet TRA1.1-L145RP.xxx er kompatible. Tjek med din Ultrasonix-repræsentant, hvis du er i tvivl.
- <sup>3</sup> Hitachi Aloka Medical: Hvis serienummeret er angivet i parenteser på listen, fx (M00621~), er det kun sonder med disse serienumre, der er kompatible til brug sammen med denne sondemodel.
- <sup>4</sup> Disse sonder indeholder lumen, der ikke kan desinficeres på højt niveau i trophon EPR- eller trophon 2-enheder. Ved desinfektion af lumen henvises til produkternes brugsanvisning (IFU), som angivet af sondens originale udstyrsfabrikanter, for oplysninger om genbehandling. I USA, Canada og Japan kan trophon EPR- og trophon 2-enheder kun anvendes til desinfektion på højt niveau af de udvendige overflader på disse sonder.
- <sup>5</sup> EchoNous (Kosmos Torso/Kosmos Torso – ONE): EMC-suppressoren skal være anbragt inde i kammeret under kabelklemmen.
- <sup>6</sup> Siemens Freestyle trådløs sondeområde: Batteriet skal tages ud før desinfektion.
- **CPP** trophon CPP (aktuator til buet sonde) er tilbehør til trophon EPR-enheden til at understøtte placeringen af validerede buede sonder i enhedskammeret. Der henvises til brugsanvisningen for trophon CPP, hvor der findes flere oplysninger om konfiguration og brug.  
**Bemærk:** trophon CPP er IKKE påkrævet for trophon2-enheden.
- **T** trophon EPR T-klemmen (se Figur 2 nedenfor) kan fås til godkendte ultralydssondekabler. Kontakt din trophon EPR-repræsentant for yderligere information eller for at bestille en T-klemme.  
**Bemærk:** T-klemmen er IKKE påkrævet for trophon2-enheden.
- **IPP** trophon2 indbygget sondeplaceringsenhed (IPP) er en fuldt integreret mekanisme i trophon2-enheden (jf. Figur 3 nedenfor), som forbedrer placeringen af alle validerede buede sonder i kammeret på trophon2. Der henvises til brugsanvisningen til trophon2 for oplysninger om anvendelsen af IPP.
- **WUPH-A** trophon Wireless Ultrasound Probe Holder-A (WUPH-A) holder en kompatibel trådløs ultralydssonde i trophon-kammeret. Den er velegnet til brug med både trophon EPR- og trophon2-enheder (se henholdsvis Figur 4 og Figur 5).

**Bemærk:** trophon WUPH-A er tilgængelig på udvalgte markeder. Kontakt en repræsentant for Nanosonics for at få mere at vide.

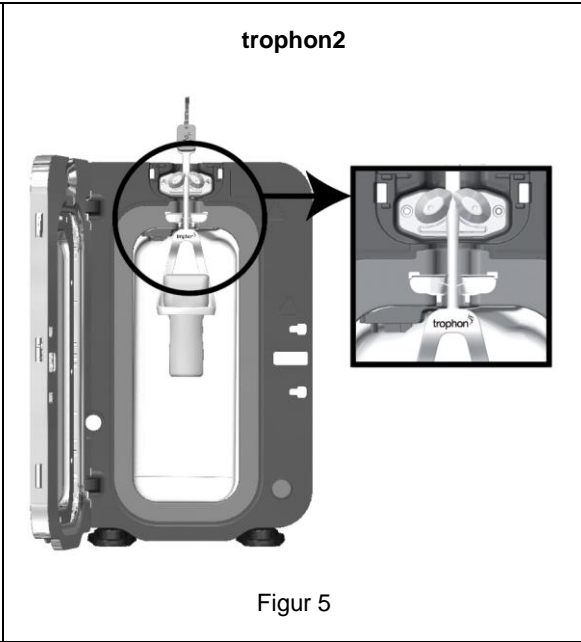
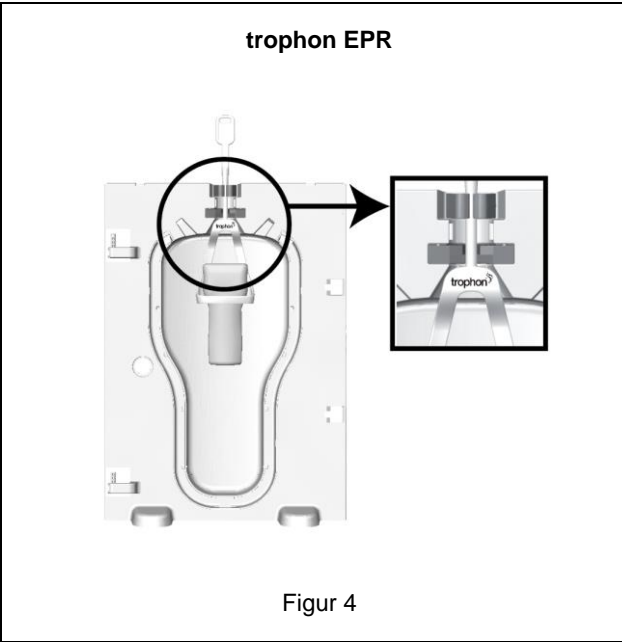
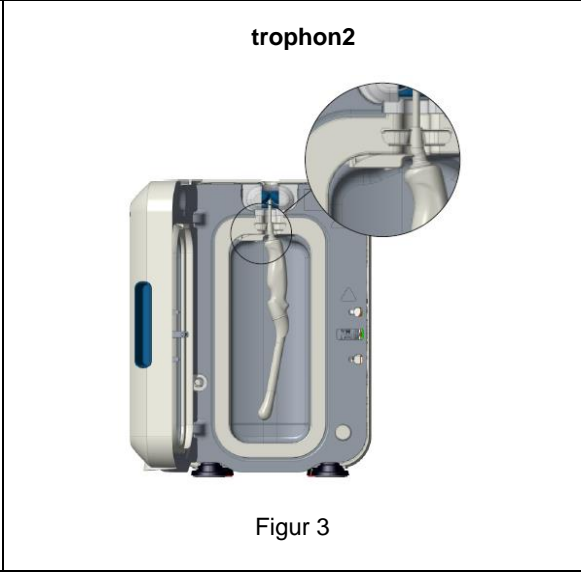
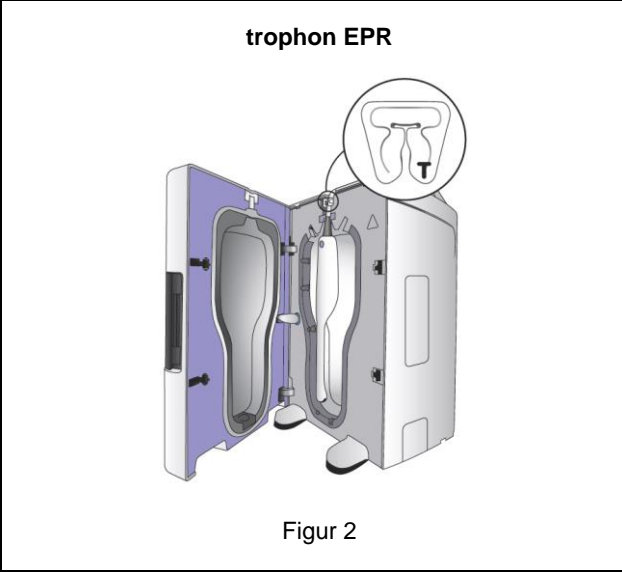

## trophon® EPR och trophon2

### Lista över kompatibla ultraljudssonder

Följande sonder på listan har godkänts för användning med trophon® EPR- och/eller trophon®2-enhet(er) efter omfattande kompatibilitetstester utförda i samarbete med instrumentens tillverkare av originalutrustning. Figur 1 visar Nanosonics rigorösa program avseende sondens kompatibilitet.

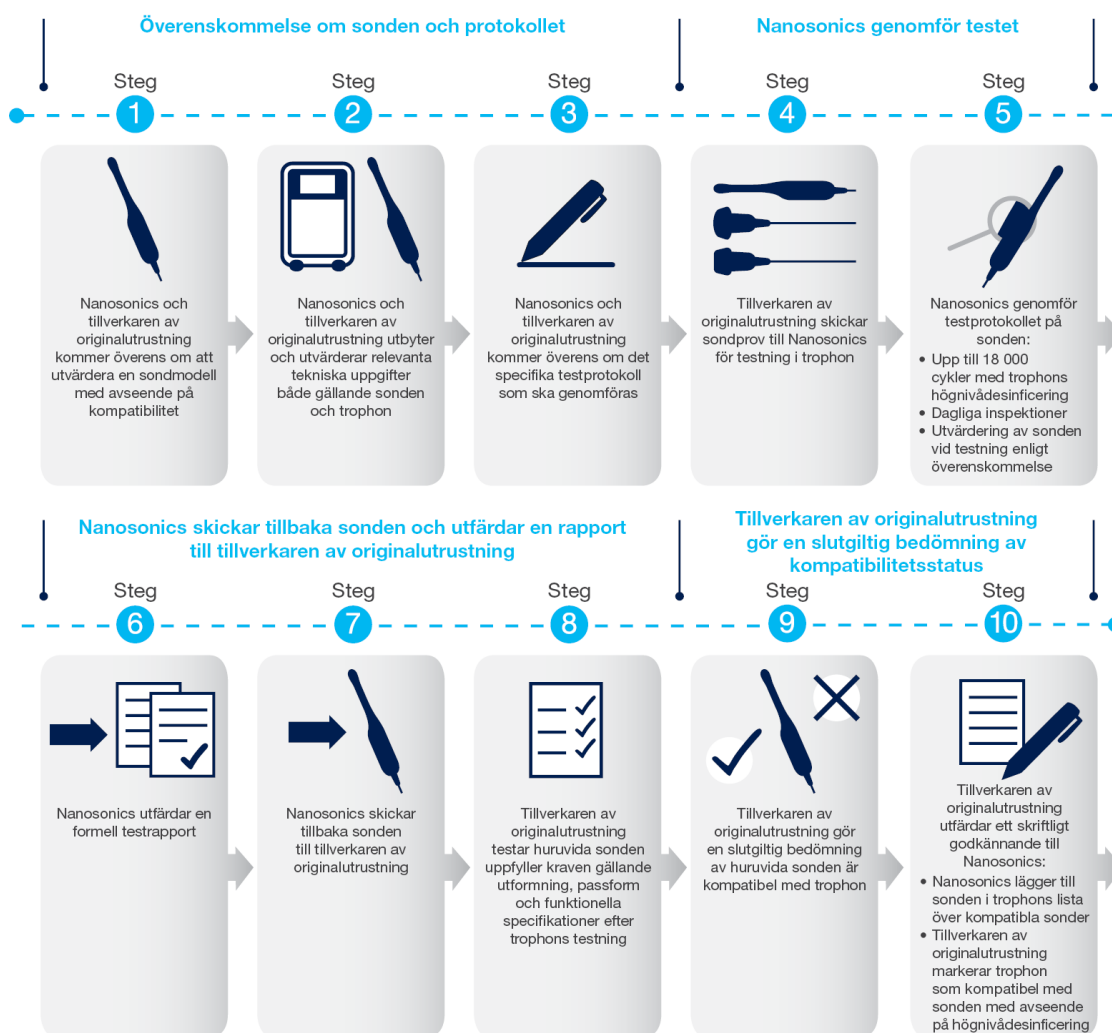

Figur 1

**Endast sonder som har godkänts gemensamt och vars kompatibilitet har verifierats av tillverkare av originalutrustning och Nanosonics läggs till i trophon EPR:s och trophon2:s lista med kompatibla ultraljudssonder.**

Godkända sonder är listade enligt tillverkare, serie (Series), gällande tillämpligt och modellnummer (Model) i tabellerna nedan.

Kontrollera din(a) sond(er)s kompatibilitet med trophon EPR- och trophon2-enheter, vilket anges med tecknet "✓" i motsvarande kolumn i tabellen.

**OBS:** Se sondtillverkarens användningsinstruktioner för information om den nivå av upparbetning som behövs efter att ha använt sonden kliniskt. Sonder som kräver sterilisering för slutlig upparbetning kan använda högnivådesinficering (HLD) som mellansteg för att minska den biologiska belastningen innan

sterilisering. I vissa fall när en sond behöver steriliseras trots att sterilisering inte är möjlig kan man överväga högnivådesinficering med ett sterilt hölje.

### **Speciella förhållanden:**

Modelltyper märkta med symboler har speciella krav när de används med trophon EPR- och trophon2-enheter.

Observera dessa speciella förhållanden vid användning av dessa sonder.

- <sup>1</sup> Prosonic (L5-10/40EPN): Endast sonder som är tillverkade efter den 30 december 2011 är kompatibla.
- <sup>2</sup> Ultrasonix (L14-5/38): Endast omvandlare med serienummerformatet TRA1.1-L145RP.xxx är kompatibla. Om du är osäker ska du kontakta din Ultrasonix-representant.
- <sup>3</sup> Hitachi Aloka Medical: Om serienumret i listan anges inom parentes, till exempel (M00621~), innebär det att endast sonder med dessa serienummer är kompatibla med sondmodellen.
- <sup>4</sup> Dessa sonder har lumen som inte kan genomgå högnivådesinficering i trophon2- eller trophon EPR-enheter. Se originaltillverkarens (OEM) bruksanvisning för information om hur man reprocessar/desinficerar lumen. I USA, Kanada och Japan får trophon2- och trophon EPR-enheter endast användas för att högnivådesinficera de externa ytorna på dessa sonder.
- <sup>5</sup> EchoNous (Kosmos Torso/Kosmos Torso – ONE): EMC-dämparen ska laddas i kammaren, nedanför kabelklämman.
- <sup>6</sup> Siemens Freestyles utbud av trådlösa sonder: Batteriet måste tas bort före desinfektion.
- **CPP** trophon CPP som är en placerare för böjda sonder (engelska: Curved Probe Positioner) och är ett tillbehör till trophon EPR-enheter som förbättrar placeringen av godkända krökta sonder i enhetens kammare. Se bruksanvisningen till trophons placerare för böjda sonder för mer information om installation och användning.  
**OBS:** trophons placerare för böjda sonder krävs INTE för trophon2-enheten.
- **T** trophon EPR T-klämman (se Figur 2 nedan) finns för identifierade ultraljudsodkablar. Kontakta din trophon EPR-representant för mer information eller för att beställa en T-klämman.  
**OBS:** T-klämman behövs inte för trophon2-enheten.
- **IPP** trophon2:s integrerade sondplacering (engelska: Integrated Probe Positioner – IPP) är en fullt integrerad mekanism i trophon2-enheten (se Figur 3 nedan) som förbättrar alla godkända krökta sonders placeringar i trophon2-kammaren. Se bruksanvisningen för trophon2 för information om hur man använder IPP.
- **WUPH-A** trophon Wireless Ultrasound Probe Holder-A (WUPH-A) har plats för en kompatibel trådlös ultraljuds sond i trophon-kammaren. Den är lämplig för användning med både trophon EPR- och trophon2-enheter (se Figur 4 respektive Figur 5).  
**Obs:** trophon WUPH-A är tillgänglig på utvalda marknader. Kontakta en Nanosonics-representant för mer information.

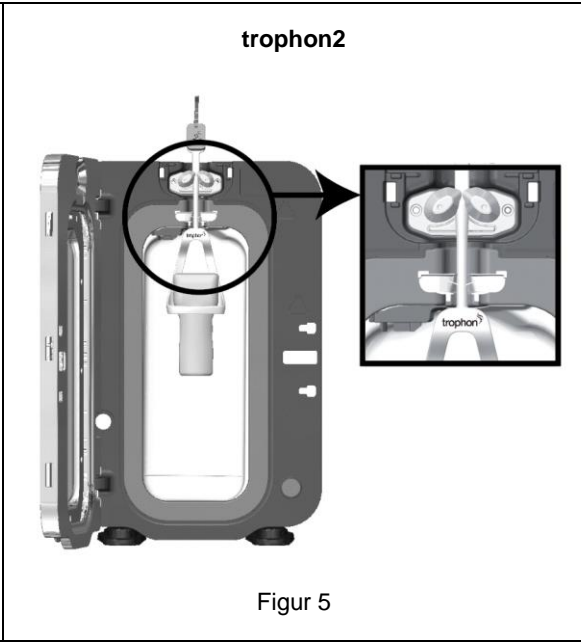
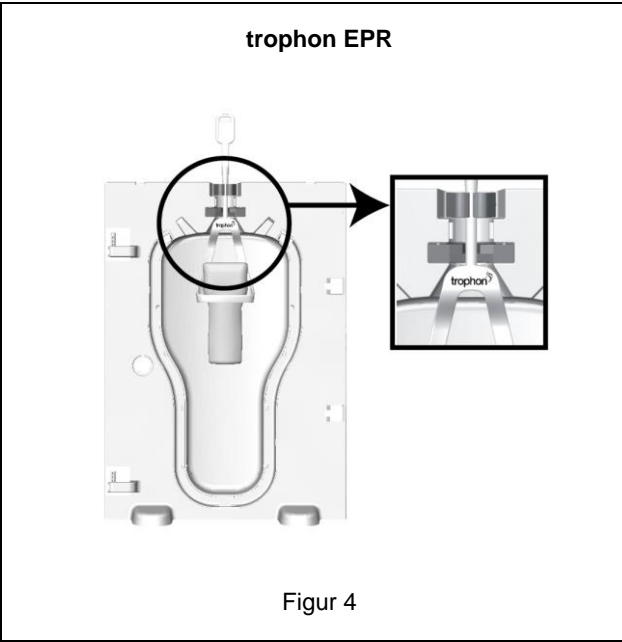
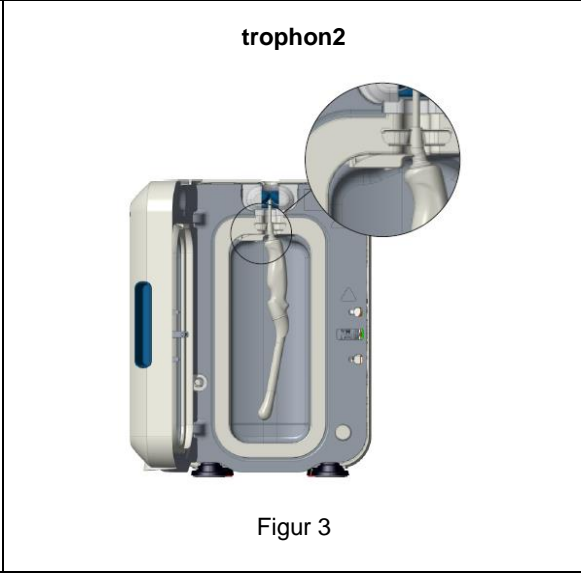
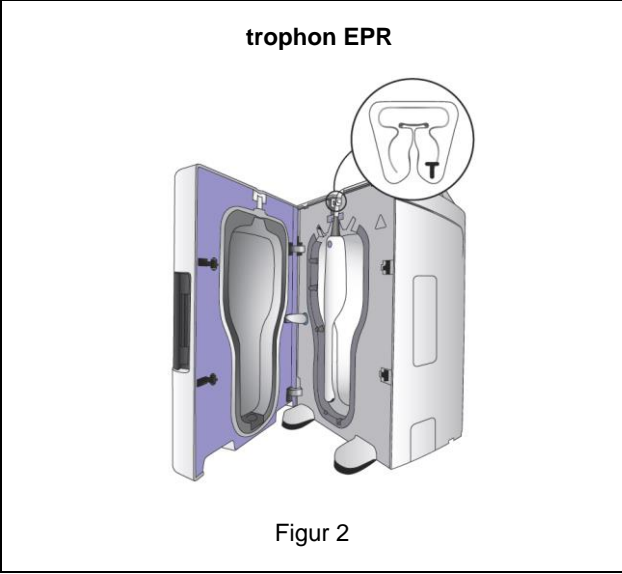

trophon®EPR および trophon2®

対応超音波プローブ製品一覧

この一覧に掲載されているプローブ製品は、委託者商標による受託製造（OEM）メーカーと連携して実施した広範な対応試験を経た上で、trophon®EPR、trophon2®との併用が既に認可されているものです。図1は、Nanosonicsの厳密なプローブ対応プログラムを示したものです。



図1

OEMとNanosonics社によって対応が認可され、かつ、承認されているプローブ製品のみが、trophon EPRおよびtrophon2対応超音波プローブ製品一覧表に追加されています。

以下の表では、メーカー別に、製品シリーズ名（Series）（該当する場合のみ）、モデル番号（Model）により、認可済みプローブ製品が記載されています。

本表の対応する列中に「✓」で示されているのが、trophon EPR および trophon2 製品に対応しているお客様のプローブ製品ですのでご確認ください。

**注記：**プローブ製品の臨床使用後に必要とされる再処理レベルに関する情報については、当該プローブ製品メーカーの取扱説明書をご覧ください。ターミナルの再処理に殺菌を必要とするプローブ製品の場合は、殺菌処理前に生物汚染度を下げるために、中間ステップとして高水準消毒（HLD）を行う場合があります。プローブ製品に殺菌処理が必要とされるが、殺菌処理ができないような一部のケースでは、そのようなプローブ製品に対して HLD を行い、かつ滅菌シースとの併用を検討することになる場合があります。

#### 特別条件

記号の付いたラベルが貼付されたモデルタイプでは、trophon EPR および trophon2 と併用する際に特別な条件が付帯しています。

これらのプローブ製品は、以下の特別条件にご留意の上ご使用ください。

- <sup>1</sup> Prosonic (L5-10/40EPN) : 2011 年 12 月 30 日以降に製造されたプローブ製品にのみ対応しています。
- <sup>2</sup> Ultrasonix (L14-5/38) : シリアル番号形式が TRA1.1-L145RP.xxx のトランスデューサーのみ対応しています。ご不明な場合は、Ultrasonix 販売代理店にお問い合わせください。
- <sup>3</sup> 日立アロカメディカル：一覧表の中で（M00621～）のようにシリアルナンバーが括弧内に指定されている場合は、そのプローブ製品モデルの使用には、指定されたシリアルナンバーのプローブ製品のみ対応しています。
- <sup>4</sup> これらのプローブ製品には、trophon EPR または trophon2 では高水準消毒が行えない内腔があります。こうした内部空間の消毒については、プローブ OEM の取扱説明書の再処理に関する記載事項をご覧ください。米国、カナダ、および日本では、trophon EPR および trophon2 は、これらのプローブ製品の外部表面の高水準消毒でのみご利用いただけます。
- <sup>5</sup> EchoNous (Kosmos Torso/Kosmos Torso – ONE): EMC サプレッサーは、ケーブルクランプの下にあるチャンバー内に装着します。
- <sup>6</sup> シーメンス **Freestyle** ワイヤレスプローブ範囲：消毒前にバッテリーを取り外す必要があります。
- <sup>CPP</sup> trophon CPP（湾曲型プローブポジショナ）は、trophon EPR チャンバー内の認可済湾曲型プローブの位置を固定するのをサポートするための trophon EPR 用付属品です。位置設定と使用についての詳しい情報については、trophon CPP 取扱説明書をご覧ください。

**注記：**trophon CPP は、trophon2 の使用に必ず必要となるものではありません。



- **T** trophon EPR T-クランプ（下図 2 参照）は、指定された超音波プローブのケーブルで使用できます。詳しい情報、または T-クランプの入手をご希望の場合は、trophon EPR 販売代理店までお問い合わせください。

**注記：**T-クランプは、trophon2 の使用に必ず必要となるものではありません。

- **IPP** trophon2 統合型プローブポジショナ（IPP）は、trophon2 内に完全に統合されているメカニズムで（下図 3 参照）、trophon2 チャンバー内のすべての認可済湾曲型プローブの位置を固定しやすくするためのメカニズムです。インテグレートドプローブポジショナーの使用方法については、trophon2 の取扱説明書をご覧ください。

- **WUPH-A** trophon Wireless Ultrasound Probe Holder-A (WUPH-A) は、互換性のあるワイヤレス超音波プローブを trophon のチャンバー内で保持します。trophon EPR および trophon2 デバイスの両方での使用に適しています（それぞれ図 4 および図 5 をご参照ください）。

**注記：**trophon WUPH-A は、一部の市場で入手できます。詳細については、Nanosonics の担当者にお問い合わせください。

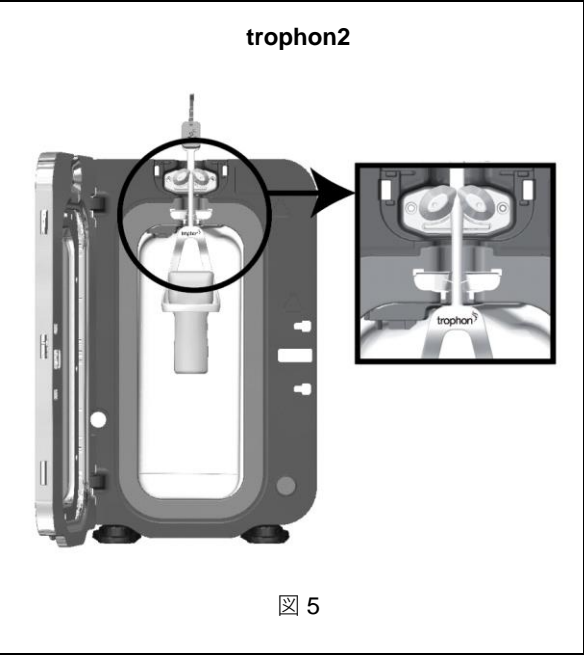
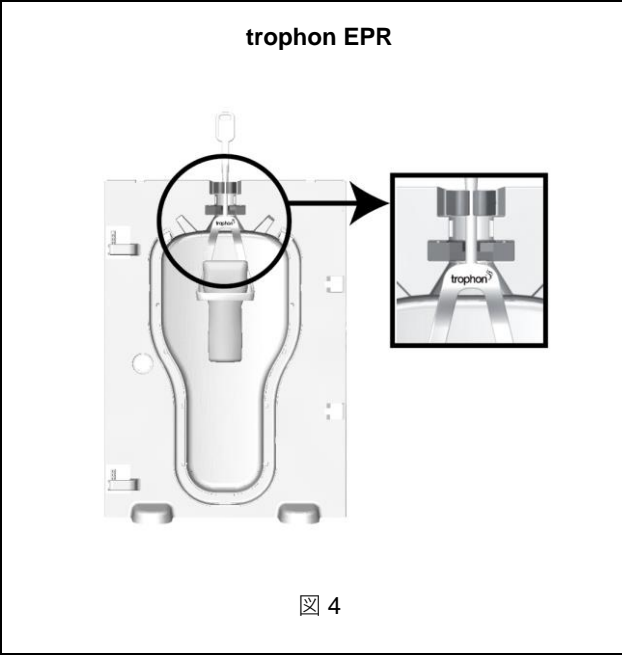
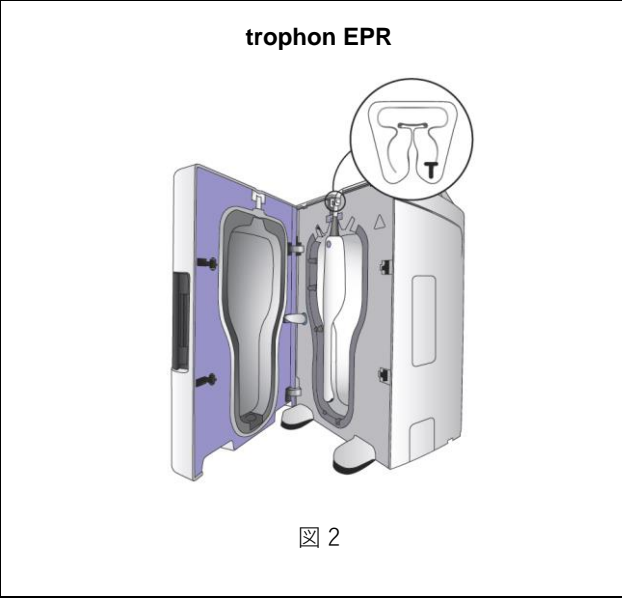

trophon® EPR dan trophon2

## Daftar Probe Ultrasound yang Kompatibel

Probe dalam daftar ini telah disetujui untuk digunakan dengan perangkat trophon® EPR dan/atau trophon®2 menyusul pengujian kompatibilitas ekstensif yang dilakukan bersama dengan Produsen Peralatan Asli (OEM) probe. Gambar 1 menunjukkan program kompatibilitas probe Nanosonics yang ketat.



Gambar 1

**Hanya probe yang telah disetujui dan didukung kompatibilitasnya bersama-sama oleh OEM dan Nanosonics yang ditambahkan ke dalam Daftar Probe Ultrasound yang Kompatibel dengan trophon EPR dan trophon2.**

Probe yang disetujui dicantumkan berdasarkan produsen, seri (Series), jika berlaku kemudian nomor model (Model) dalam tabel di bawah.

Harap periksa kompatibilitas probe Anda dengan perangkat trophon EPR dan trophon2, yang ditunjukkan oleh: '✓' di kolom tabel yang sesuai.

**Catatan:** Lihat Petunjuk Penggunaan (IFU) produsen probe untuk mengetahui informasi tentang tingkat pemrosesan ulang yang diperlukan menyusul kasus penggunaan klinis probe. Probe yang membutuhkan sterilisasi untuk pemrosesan ulang terminal dapat menggunakan desinfeksi tingkat tinggi (HLD) sebagai langkah perantara, untuk mengurangi bioburden sebelum sterilisasi. Dalam beberapa kasus ketika probe membutuhkan sterilisasi, tetapi sterilisasi tidak dimungkinkan, HLD probe dan penggunaan dengan selubung steril dapat dipertimbangkan.

### Kondisi Khusus:

Jenis model yang dilabeli dengan simbol memiliki kondisi khusus saat digunakan dengan perangkat trophon EPR dan trophon2.

Harap perhatikan kondisi khusus tersebut saat menggunakan probe ini.

- <sup>1</sup> Prosonic (L5-10/40EPN): Hanya probe yang diproduksi setelah 30 Desember 2011 yang kompatibel.
- <sup>2</sup> Ultrasonix (L14-5/38): Hanya transduser dengan format nomor seri TRA1.1-L145RP.xxx yang kompatibel. Jika tidak yakin, konfirmasi dengan perwakilan Ultrasonix.
- <sup>3</sup> Hitachi Aloka Medical: Apabila nomor seri dicantumkan dalam daftar dengan tanda kurung misalnya (M00621~), hanya probe dengan nomor seri ini yang kompatibel untuk digunakan bagi model probe ini.
- <sup>4</sup> Probe ini mengandung lumen yang tidak dapat didisinfeksi tingkat tinggi dalam perangkat trophon EPR atau trophon2. Untuk disinfeksi lumen, lihat Petunjuk Penggunaan produsen peralatan asli probe untuk mengetahui informasi tentang pemrosesan ulang. Di AS, Kanada, dan Jepang, perangkat trophon EPR dan trophon2 dapat digunakan untuk disinfeksi tingkat tinggi permukaan eksternal probe tersebut saja.
- <sup>5</sup> EchoNous (Kosmos Torso/Kosmos Torso – ONE): Supresor EMC harus dimuat di dalam bilik, di bawah penjepit kabel.
- <sup>6</sup> Jajaran probe nirkabel Siemens Freestyle: Baterai harus dilepas sebelum melakukan disinfeksi.
- **CPP** trophon CPP (Curved Probe Positioner) adalah aksesori perangkat trophon EPR untuk mendukung penempatan probe lengkung yang disetujui dalam ruang perangkat. Lihat Petunjuk Penggunaan trophon CPP untuk mengetahui informasi lebih lanjut tentang pengaturan dan penggunaan.  
**Catatan:** trophon CPP TIDAK dibutuhkan untuk perangkat trophon2.
- **T** trophon EPR T-Clamp (lihat Gambar 2 di bawah) tersedia untuk kabel probe ultrasound yang diidentifikasi. Harap hubungi perwakilan trophon EPR untuk mengetahui informasi lebih lanjut, atau minta T-Clamp.  
**Catatan:** T-Clamp TIDAK dibutuhkan untuk perangkat trophon2.
- **IPP** trophon2 Integrated Probe Positioner (IPP) adalah mekanisme yang sepenuhnya terintegrasi dalam perangkat trophon2 (lihat Gambar 3 di bawah) yang meningkatkan penempatan semua probe lengkung yang disetujui dalam ruang trophon2. Lihat Manual Pengguna trophon2 untuk mengetahui informasi tentang cara menggunakan IPP.
- **WUPH-A** trophon Wireless Ultrasound Probe Holder-A (WUPH-A) merupakan dudukan probe ultrasound nirkabel yang kompatibel dalam ruang trophon. Dudukan ini cocok untuk digunakan dengan perangkat trophon EPR dan trophon2 (lihat Gambar 4 dan Gambar 5).  
**Catatan:** trophon WUPH-A tersedia di pasar tertentu. Hubungi perwakilan Nanosonics untuk mengetahui informasi lebih lanjut.

**trophon EPR**



Gambar 2

**trophon2**

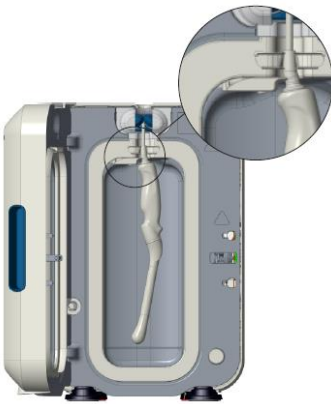

Gambar 3

**trophon EPR**

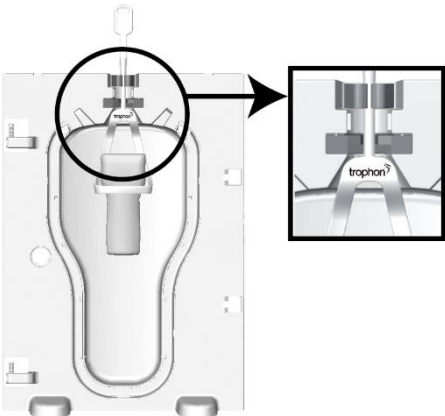

Gambar 4

**trophon2**

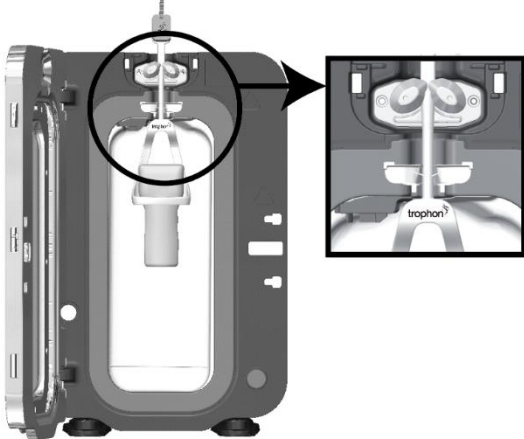

Gambar 5

### Alpinion Medical Systems

Model	trophon EPR	trophon2
C1-6	✓	✓
C1-6i	✓	✓
C1-6T	✓	✓
C5-8N	✓ <sup>T</sup>	✓
C5-8NT	✓ <sup>T</sup>	✓
CL11-6	✓	✓
EC2-11H	✓	✓
EC3-10	✓	✓
EC3-10H	✓	✓
EC3-10T	✓	✓
EC3-10X	✓	✓
IO3-12	✓	✓
IO8-17	✓	✓
IO8-17T	✓	✓
L3-12	✓	✓
L3-12H	✓	✓
L3-12HWD	✓	✓
L3-12i	✓	✓
L3-12NGS	✓	✓
L3-12T	✓	✓
L3-12X	✓	✓
L3-8	✓	✓
L3-8i	✓	✓
L3-15H	✓	✓
L8-17	✓	✓
L8-17H	✓	✓
L8-17i	✓	✓
L8-17X	✓	✓
L10-25H	✓	✓
MP1-5X	✓ <sup>T</sup>	✓
P1-5CT	✓	✓
SC1-4H	✓	✓
SC1-4HS	✓	✓
SC1-6	✓	✓
SC1-6H	✓	✓
SC1-7H	✓	✓
SC2-11H	✓	✓
SC2-9H	✓	✓
SL3-19H	✓	✓
SL3-19X	✓	✓
SP1-5	✓ <sup>T</sup>	✓

### Alpinion Medical Systems

Model	trophon EPR	trophon2
SP1-5i	✓ <sup>T</sup>	✓
SP1-5T	✓ <sup>T</sup>	✓
SP1-5X	✓	✓
SP3-8	✓	✓
SP3-8T	✓	✓
SVC1-6	✓	✓
SVC1-6H	✓	✓
SVC1-8H	✓	✓
VC1-6	✓	✓
VC1-6T	✓	✓
VE3-10H	✓ <sup>T</sup>	✓

**BD**

Model	Series	trophon EPR	trophon2
Ultrasound System Cue 32mm Linear Probe P/N: 9770601	Site~Rite™ 8	✓	✓
Vascular Access System Linear Probe P/N: 9770703	BD Prevue™ II	✓ <sup>T</sup>	✓
Vascular Access System Vascular Access Probe P/N: 9770704	BD Prevue™ II	✓	✓
Ultrasound System Cue 20mm Linear Probe P/N: 9770603	BD Prevue™ II	✓	✓
Vascular Access System Vascular Access Probe P/N: 9770703	BD Prevue™ II	✓ <sup>T</sup>	✓
Ultrasound System Cue™ Linear Probe	SiteRite™ 9	✓	✓

### BK Medical

Model	trophon EPR	trophon2
5P1 (9077)	✓	✓
6C2 (9040)	✓	✓
6C2s (9023)	✓	✓
8L2 (9032)	✓	✓
9C2 (9002)	✓	✓
10L2w (9022)	✓	✓
13L4w (9011)	✓	✓
14L3 (9051)	✓	✓
18L5 (9070)	✓	✓
8667	✓	✓
8808e	✓	✓
8811	✓	✓
8815	✓	✓
8816	✓	✓
8818	✓ <sup>T</sup>	✓
8819	✓	✓
8820e	✓	✓
8822	✓	✓
8823	✓	✓
8824	✓	✓
9067 (E14C4)	✓	✓
E10C4 (9019)	✓	✓
E11C3b (9008)	✓	✓
E13C2 (9029)	✓	✓
E14C4t (9018)	✓	✓
N13C5	✓	✓

### Butterfly Network

Model	trophon EPR	trophon2
iQ		✓
iQ +		✓
iQ3		✓

### Canon Medical Systems Corporation (Toshiba)

Model	Series	trophon EPR	trophon2
PLC-1004LT	-	✓ <sup>T</sup>	✓
PLC-704LT	-	✓ <sup>T</sup>	✓

### Canon Medical Systems Corporation (Toshiba)

Model	Series	trophon EPR	trophon2
PLG-506M	G Series	✓	✓
PLG-805S	G Series	✓	✓
PLI-1205BX	I Series	✓	✓
PLI-2002BT	I Series	✓	✓
PLI-2004BX	I Series	✓	✓
PLI-605BX	-	✓ <sup>T</sup>	✓
PLI-705BX	I Series	✓	✓
PLM-1202S	M Series	✓	✓
PLM-1204AT	M Series	✓	✓
PLM-503AT	M Series	✓	✓
PLM-703AT	M Series	✓	✓
PLM-805AT	M Series	✓	✓
PLQ-1203A	Q Series	✓	✓
PLQ-703A	Q Series	✓	✓
PLQ-805A	Q Series	✓	✓
PLT-1005BT	T Series	✓	✓
PLT-1202BT	T Series	✓	✓
PLT-1202S	T Series	✓	✓
PLT-1204BT	T Series	✓	✓
PLT-1204BX	T Series	✓	✓
PLT-1204MV	T Series	✓	✓
PLT-1204ST	T Series	✓	✓
PLT-375SC	T Series	✓	✓
PLT-604AT	T Series	✓	✓



**Canon Medical Systems Corporation  
(Toshiba)**

Model	Series	trophon EPR	trophon2
PLT-704AT	T Series	✓	✓
PLT-704SBT	T Series	✓	✓
PLT-704ST	T Series	✓	✓
PLT-705BT	T Series	✓	✓
PLT-705BTF	T Series	✓	✓
PLT-705BTH	T Series	✓	✓
PLT-805AT	T Series	✓	✓
PLU-1005BT	U Series	✓	✓
PLU-1202BT	U Series	✓	✓
PLU-1204BT	U Series	✓	✓
PLU-704BT	U Series	✓ <sup>T</sup>	✓
PLU-705BTF	U Series	✓ <sup>T</sup>	✓
PLU-705BTH	U Series	✓ <sup>T</sup>	✓
PLU-805BT	-	✓ <sup>T</sup>	✓
PLU-1004SD	U Series	✓ <sup>T</sup>	✓
PLU-2002BT	-	✓	✓
PSI-30BX	I Series	✓ <sup>T</sup>	✓
PSI-30VX	I Series	✓ <sup>T</sup>	✓
PSI-40VX	I Series	✓ <sup>T</sup>	✓
PSI-50VX	I Series	✓ <sup>T</sup>	✓
PSI-70BT	I Series	✓ <sup>T</sup>	✓
PSC-25LT	-	✓ <sup>T</sup>	✓
PSM-20CT	M Series	✓ <sup>T</sup>	✓
PSM-25AT	M Series	✓ <sup>T</sup>	✓

**Canon Medical Systems Corporation  
(Toshiba)**

Model	Series	trophon EPR	trophon2
PSM-30BT	M Series	✓ <sup>T</sup>	✓
PSM-37AT	M Series	✓ <sup>T</sup>	✓
PSM-37CT	M Series	✓ <sup>T</sup>	✓
PSM-50AT	M Series	✓ <sup>T</sup>	✓
PSM-70AT	M Series	✓ <sup>T</sup>	✓
PST-20CT	T Series	✓	✓
PST-25AT	T Series	✓	✓
PST-25BT	T Series	✓ <sup>T</sup>	✓
PST-25ST	T Series	✓ <sup>T</sup>	✓
PST-28BT	T Series	✓ <sup>T</sup>	✓
PST-30BT	T Series	✓ <sup>T</sup>	✓
PST-30SBT	T Series	✓	✓
PST-37CT	T Series	✓	✓
PST-50AT	T Series	✓ <sup>T</sup>	✓
PST-50BT	T Series	✓ <sup>T</sup>	✓
PST-65AT	T Series	✓ <sup>T</sup>	✓
PST-65AT - 6.5	-	✓ <sup>T</sup>	✓
PST-65BT	T Series	✓ <sup>T</sup>	✓
PSU-25BT	U Series	✓ <sup>T</sup>	✓
PSU-30BT	-	✓ <sup>T</sup>	✓
PSU-30ST	-	✓	✓
PSU-50BT	U Series	✓ <sup>T</sup>	✓
PSU-70BT	U Series	✓ <sup>T</sup>	✓

**Canon Medical Systems Corporation  
(Toshiba)**

Model	Series	trophon EPR	trophon2
PVC-375LT	-	✓ <sup>T</sup>	✓
PVC-781VLT	-	✓ <sup>T</sup>	✓
PVF-381MT	F Series	✓	✓
PVF-575AT	F Series	✓	✓
PVF-620ST	F Series	✓	✓
PVF-738F	F Series	✓	✓
PVF-738H	F Series	✓	✓
PVF-745V	F Series	✓	✓
PVG-366M	G Series	✓	✓
PVG-381M	G Series	✓	✓
PVG-600S	G Series	✓	✓
PVG-601V	G Series	✓	✓
PVG-630V	G Series	✓	✓
PVG-681S	G Series	✓	✓
PVG-720S	G Series	✓	✓
PVI-450BXP	I Series	✓	✓
PVI-475BT	I Series	✓	✓
PVI-475BX	I Series	✓	✓
PVI-482BX	I Series	✓ <sup>T</sup>	✓
PVI-574BX	I Series	✓	✓
PVM-375AT	M Series	✓	✓
PVM-375MV	M Series	✓	✓
PVM-381AT	M Series	✓	✓
PVM-620ST	M Series	✓	✓

**Canon Medical Systems Corporation  
(Toshiba)**

Model	Series	trophon EPR	trophon2
PVM-621VT	M Series	✓	✓
PVM-651VT	M Series	✓	✓
PVM-656AT	M Series	✓	✓
PVM-662AT	M Series	✓	✓
PVM-672AT	M Series	✓	✓
PVM-740RT	M Series		✓
PVQ-375A	Q Series	✓	✓
PVQ-381A	Q Series	✓	✓
PVQ-641V	Q Series	✓	✓
PVQ-662A	Q Series	✓	✓
PVQ-674A	Q Series	✓	✓
PVT-375BT	T Series	✓	✓
PVT-375MV	T Series	✓	✓
PVT-375SC	T Series	✓	✓
PVT-375ST	T Series	✓	✓
PVT-382BT	T Series	✓	✓
PVT-382MV	T Series	✓	✓
PVT-475BT	T Series	✓	✓
PVT-482BT	T Series	✓	✓
PVT-574BT	T Series	✓ <sup>T</sup>	✓
PVT-575MV	T Series	✓	✓
PVT-661VT	T Series	✓	✓
PVT-674BT	T Series	✓	✓
PVT-675MV	T Series	✓	✓

**Canon Medical Systems Corporation  
(Toshiba)**

Model	Series	trophon EPR	trophon2
PVT-675MVL	T Series	✓	✓
PVT-675MVS	T Series	✓	✓
PVT-681MV	T Series	✓	✓
PVT-681MVL	T Series	✓	✓
PVT-712BT	T Series	✓ <sup>T</sup>	✓
PVT-745BTF	T Series	✓ <sup>T</sup>	✓
PVT-745BTH	T Series	✓ <sup>T</sup>	✓
PVT-745BTV	T Series	✓	✓
PVT-770RT	T Series	✓	✓
PVT-781VT	T Series	✓	✓
PVT-781VTE	T Series	✓	✓
PVU-366ST	-	✓	✓
PVU-375BT	U Series	✓ <sup>T</sup>	✓
PVU-375SDT	U Series	✓ <sup>T</sup>	✓
PVU-382BT	U Series	✓ <sup>T</sup>	✓
PVU-382SDT	U Series	✓ <sup>T</sup>	✓
PVU-475BT	-	✓ <sup>T</sup>	✓
PVU-674BT	U Series	✓	✓
PVU-674MVS	-	✓	✓
PVU-674MV	U Series	✓	✓
PVU-681MVL	U Series	✓	✓
PVU-712BTE	-	✓ <sup>T</sup>	✓
PLU-1003ST	-	✓ <sup>T</sup>	✓
PLU-704SDT	U Series	✓ <sup>T</sup>	✓

**Canon Medical Systems Corporation  
(Toshiba)**

Model	Series	trophon EPR	trophon2
PVU-712BT	U Series	✓ <sup>T</sup>	✓
PVU-745BTF	U Series	✓ <sup>T</sup>	✓
PVU-745BTH	U Series	✓ <sup>T</sup>	✓
PVU-745BTV	U Series	✓ <sup>T</sup>	✓
PVU-770ST	U Series	✓ <sup>T</sup>	✓
PVU-781VT	U Series	✓	✓
PVU-781VST	-	✓	✓
PVU-781VTE	U Series	✓	✓

**CareStream**

Model	trophon EPR	trophon2
5P1	✓	
6C2	✓	
6C2s	✓	
8L2	✓	
9C2	✓	
10L2W	✓	
13L4w	✓	
14L3	✓	
18L5	✓	
18L5s	✓	
E10C4	✓	
E14C4	✓	
N13C5	✓	

**Chison**

Model	trophon EPR	trophon2
D6C12L 6.0MHZ	✓ <sup>CPP</sup>	
D7C10L 7.5MHZ	✓ <sup>CPP</sup>	

**EchoNous**

Model	trophon EPR	trophon2
EchoNous Vein	✓	✓

### EchoNous

Model	trophon EPR	trophon2
Kosmos Torso <sup>5</sup>		✓
Kosmos Torso-ONE <sup>5</sup>		✓
LEXSA		✓

### Esaote

Model	trophon EPR	trophon2
AC2541	✓	✓
BC431	✓	✓
BC441	✓	✓
BE1123	✓	✓
BL433	✓	✓
C1-8	✓	✓
C2-9	✓	✓
CA1123	✓	✓
CA123	✓	✓
CA431	✓	✓
CA541	✓	✓
CA631	✓	✓
E3-12 <sup>4</sup>	✓	✓
EC1123 <sup>4</sup>	✓	✓
EC123 <sup>4</sup>	✓	✓
L8-24	✓	✓
LA332E	✓	✓
LA435	✓	✓
LA533	✓	✓
mC 3-11	✓	✓
P1-5	✓	✓
P2-5-13	✓	✓
P3-11	✓	✓
PA023E	✓	✓
PA121E	✓	✓
PA122E	✓	✓
PA240	✓	✓
PA250	✓	✓
SB2C41	✓	✓
SB3123	✓	✓
SB3133	✓	✓
SC3123	✓	✓
SE3123 <sup>4</sup>	✓	✓
SE3133 <sup>4</sup>	✓	✓

### Esaote

Model	trophon EPR	trophon2
SL1543	✓	✓
SL2325	✓	✓
SL3235	✓	✓
SL3332	✓	✓
SP2430	✓	✓
SP2730	✓	✓

### GE

Model	trophon EPR	trophon2
3.5C	✓	✓
3.5C gray lens	✓	✓
3.5CS	✓	✓
3C	✓	✓
3Cb	✓	✓
3CRF	✓	✓
3CRF-D	✓	✓
3C-RS	✓	✓
3S	✓	✓
3Sc-RS	✓	✓
3S-D	✓	✓
3S-LC	✓	✓
3Sp	✓	✓
3Sp-D	✓	✓
3SR	✓	✓
3S-RC	✓	✓
3S-RS	✓	✓
3S-SC	✓	✓
3V	✓	✓
3V-D	✓	✓
4C	✓	✓
4C-A	✓	✓
4C-D	✓	✓
4C-RS	✓	✓
4C-SC	✓	✓
4D10L	✓	✓
4D16L	✓	✓
4D3C-L	✓	✓
4D5C-L	✓	✓
4D8C	✓	✓
4DE7C	✓	✓
4S	✓	✓

**GE**

Model	trophon EPR	trophon2
4V-D	✓	✓
4Vc-D	✓	✓
546L	✓	✓
5C	✓	✓
5CS	✓	✓
5S	✓	✓
5S-LC	✓	✓
5S-RS	✓	✓
6S	✓	✓
6S-D	✓	✓
6S-RS	✓	✓
739L	✓	✓
7L	✓	✓
7S	✓	✓
7S-RS	✓	✓
8C	✓	✓
8C-RS	✓ <sup>T</sup>	✓
8L	✓	✓
8L-RS	✓	✓
9L	✓	✓
9L-D	✓	✓
9L-RS	✓	✓
10L	✓	✓
10LB	✓	✓
10Lb-RS	✓	✓
11L	✓	✓
11L-D	✓	✓
12L	✓	✓
12L-RS	✓	✓
12L-SC	✓	✓
12S-D	✓	✓
12S-RS	✓	✓
AB2-5	✓	✓
AB2-7	✓	✓
AB2-7-D	✓	✓
AB2-7-RS	✓	✓
AB4-8	✓	✓
AC2-5	✓	✓
BE9CS	✓	✓
BE9CS-D	✓	✓
BE9CS-RS	✓	✓
C1-5-D	✓	✓

**GE**

Model	trophon EPR	trophon2
C1-5-RS	✓	✓
C1-6-D	✓	✓
C1-6VN-D	✓	✓
C2-5-RC	✓	✓
C2-6B-D	✓	✓
C2-7-D	✓ <sup>T</sup>	✓
C2-7-D-LC	✓	✓
C2-7VN-D	✓	✓
C2-9-D	✓	✓
C2-9-RS	✓	✓
C2-9VN-D	✓	✓
C3-10-D	✓ <sup>T</sup>	✓
C31	✓	✓
C358	✓	✓
C36	✓	✓
C364	✓	✓
C386	✓	✓
C4-8-D	✓	✓
C55	✓	✓
C551	✓	✓
C721	✓	✓
CAE	✓	✓
CBF	✓	✓
CS	✓	✓
CZB	✓	✓
E8C	✓ <sup>CPP, T</sup>	✓ <sup>IPP</sup>
E8C-RS	✓ <sup>CPP</sup>	✓ <sup>IPP</sup>
E8CS	✓ <sup>CPP</sup>	✓ <sup>IPP</sup>
E8CS-RC	✓ <sup>CPP</sup>	✓ <sup>IPP</sup>
E8Cs-RS	✓ <sup>CPP</sup>	✓ <sup>IPP</sup>
E8CS-SC	✓ <sup>CPP</sup>	✓ <sup>IPP</sup>
eM6C	✓	✓
G3C Probe on Vscan		✓
G3S Probe on Vscan		✓
i12L	✓	✓
i12L-RS	✓	✓
I739	✓	✓
I739-RS	✓	✓
IC5-9	✓	✓
IC5-9-D	✓ <sup>CPP</sup>	✓ <sup>IPP</sup>

**GE**

Model	trophon EPR	trophon2
IC5-9H	✓CPP	✓IPP
IC5-9W-RS	✓CPP	✓IPP
IC9-RS	✓T	✓
IC9B-RS	✓CPP, T	✓IPP
L12n-RS	✓	✓
L12n-SC	✓	✓
L2-9-D	✓	✓
L2-9VN-D	✓	✓
L3-12-D	✓	✓
L39	✓	✓
L3-9i-D	✓	✓
L3-9i-RS	✓	✓
L3-12-RS	✓	✓
L4-12t-RS	✓	✓
L4-20t-RS	✓	✓
L4-20t-D	✓	✓
L6-12-RC	✓	✓
L6-12-RS	✓	✓
L6-24-D	✓	✓
L76	✓	✓
L764	✓	✓
L8-18i	✓	✓
L8-18i-D	✓	✓
L8-18i-RS	✓	✓
L8-18i-SC	✓	✓
LA39	✓	✓
LB	✓	✓
LD	✓	✓
LE	✓	✓
LH	✓	✓
LI	✓	✓
LT	✓	✓
M12L	✓	✓
M12L-H	✓	✓
M3S	✓	✓
M4S	✓	✓
M4S-D	✓	✓
M4S-RS	✓	✓
M5Sc-D	✓	✓
M5Sc-RS	✓	✓
M5S-D	✓	✓
M6C	✓	✓

**GE**

Model	trophon EPR	trophon2
M7C	✓	✓
M7C-H	✓	✓
M7C MiH	✓	✓
M12L MiH	✓	✓
ML4-20-D	✓	✓
ML4-20VN-D	✓	✓
ML6-15	✓	✓
ML6-15-D	✓	✓
ML6-15-RS	✓	✓
PA2-5	✓	✓
PA2-5P	✓	✓
PA4-7	✓	✓
PA6-8	✓	✓
PA6-8-D	✓	✓
PCW4.0	✓	✓
RAB2-5	✓	✓
RAB2-5-D	✓	✓
RAB2-5L	✓	✓
RAB2-5-RS	✓	✓
RAB2-6-RS	✓	✓
RAB4-8-D	✓	✓
RAB4-8L	✓	✓
RAB4-8P	✓	✓
RAB4-8-RS	✓	✓
RAB6-D	✓	✓
RAB6-RS	✓	✓
RAM3-8	✓	✓
RIC5-9	✓	✓
RIC5-9A-RS	✓	✓
RIC5-9-D	✓	✓
RIC5-9H	✓	✓
RIC5-9-RS	✓	✓
RIC5-9W	✓	✓
RIC5-9W-RS	✓	✓
RIC6-12-D	✓	✓
RIC10-D	✓	✓
RM14L	✓	✓
RM7C	✓	✓
RM6C	✓	✓
RNA5-9	✓	✓
RNA5-9-D	✓	✓
RNA5-9RS	✓	✓

### GE

Model	trophon EPR	trophon2
RSM5-14	✓	✓
RSP5-12	✓	✓
RSP6-12	✓	✓
RSP6-16	✓	✓
RSP6-16-D	✓	✓
RSP6-16-RS	✓	✓
S2-5-D	✓	✓
S220	✓	✓
S222	✓	✓
S316	✓	✓
S317	✓	✓
S611	✓	✓
SCW2.0	✓	✓
SP6-12	✓	✓
T739	✓	✓
T739-RS	✓	✓
Vscan Air™ CL	✓ WUPH-A	✓ WUPH-A
Vscan Air™ SL	✓ WUPH-A	✓ WUPH-A

### Hitachi Aloka Medical (Fujifilm Healthcare)

Model	trophon EPR	trophon2
C22I	✓	✓
C22K	✓	✓
C22P	✓	✓
C22T	✓	✓
C23	✓ <sup>T</sup>	✓
C23RV	✓ <sup>T</sup>	✓
C25	✓	✓
C251	✓	✓
C252	✓ <sup>T</sup>	✓
C253	✓ <sup>T</sup>	✓
C25P	✓	✓
C35	✓	✓
C41	✓	✓
C41B	✓ <sup>CPP</sup>	✓ <sup>IPP</sup>
C41RP	✓	✓
CC41R2	✓	✓
C41V	✓	✓
C41V1	✓	✓

### Hitachi Aloka Medical (Fujifilm Healthcare)

Model	trophon EPR	trophon2
C42	✓	✓
421	✓	✓
C42K	✓	✓
C42T	✓	✓
CA2-8AD-H	✓	✓
CC41R	✓	✓
CC41R1	✓	✓
CF4-9-H	✓	✓
CL4416R	✓	✓
CL4416R1	✓	✓
EUP- C514	✓	✓
EUP-053L	✓	✓
EUP-B512	✓	✓
EUP-B514	✓	✓
EUP-B712	✓	✓
EUP-B715	✓	✓
EUP-C318T	✓	✓
EUP-C324T	✓	✓
EUP-C511	✓	✓
EUP-C516	✓	✓
EUP-C524	✓	✓
EUP-C532	✓	✓
EUP-C715	✓	✓
EUP-F334	✓	✓
EUP-F531	✓	✓
EUP-L52	✓	✓
EUP-L53	✓	✓
EUP-053L	✓	✓
EUP-L53S	✓	✓
EUP-L54MA	✓	✓
EUP-L73S	✓	✓
EUP-L74M	✓	✓
EUP-L75	✓	✓
EUP-LS85	✓	✓
EUP-O33JA	✓	✓
EUP-O53T	✓	✓
EUP-O54J	✓	✓
EUP-O732T	✓	✓
EUP-S50A	✓	✓
EUP-S52	✓	✓
EUP-S63	✓	✓

### Hitachi Aloka Medical (Fujifilm Healthcare)

Model	trophon EPR	trophon2
EUP-S70	✓	✓
EUP-S72	✓	✓
EUP-S80	✓	✓
EUP-V53W	✓	✓
EUP-V73W	✓	✓
EVN4-9-H	✓	✓
L31KP	✓ <sup>T</sup>	✓
L34	✓	✓
L35	✓	✓
L43K	✓ <sup>T</sup>	✓
L44	✓	✓
L44K	✓	✓
L441	✓	✓
L442	✓	✓
L46K	✓	✓
L46K1	✓	✓
L51K		✓
L53K	✓	✓
L53K1	✓	✓
L55	✓	✓
L64	✓	✓
LA3-16AD-H	✓	✓
MXS1	✓	✓
S11		✓
S12	✓	✓
S21	✓	✓
S121	✓ <sup>T</sup>	✓
S211	✓	✓
S22	✓	✓
S31	✓	✓
S31KP	✓	✓
S42	✓	✓
SML44	✓	✓
UST-2265-2	✓	✓
UST-2266-5	✓	✓
UST-52105	✓	✓
UST-52108	✓	✓
UST-52114P	✓	✓
UST-52124	✓	✓
UST-52127	✓	✓

### Hitachi Aloka Medical (Fujifilm Healthcare)

Model	trophon EPR	trophon2
UST-52129	✓	✓
UST-5242D-2.5/2	✓	✓
UST-5244-3.5	✓	✓
UST-5255-2.5	✓	✓
UST-5256-3.5	✓	✓
UST-5257-5	✓	✓
UST-5263D-2.5/2	✓	✓
UST-5265-2.5	✓	✓
UST-5266-3.5	✓	✓
UST-5267-5	✓	✓
UST-5268P-5 (M00151~) <sup>3</sup>	✓	✓
UST-5274-2.5	✓	✓
UST-5275-3.5	✓	✓
UST-5276-5	✓	✓
UST-5279-3.5	✓	✓
UST-5283-2.5	✓	✓
UST-5284-2.5 (M00264~) <sup>3</sup>	✓	✓
UST-5285-3.5 (M00264~) <sup>3</sup>	✓	✓
UST-5286-2.5 (M00694~) <sup>3</sup>	✓	✓
UST-5287-3.5 (M00484~) <sup>3</sup>	✓	✓
UST-5292-5 (M00161~) <sup>3</sup>	✓	✓
UST-5294-5 (M00236~) <sup>3</sup>	✓	✓
UST-5295	✓	✓
UST-5296	✓	✓



### Hitachi Aloka Medical (Fujifilm Healthcare)

Model	trophon EPR	trophon2
UST-5297	✓	✓
UST-5298	✓	✓
UST-5299	✓	✓
UST-533	✓	✓
UST-534	✓	✓
UST-535	✓	✓
UST-536	✓	✓
UST-5410	✓	✓
UST-5410H	✓	✓
UST-5411	✓	✓
UST-5412	✓	✓
UST-5413	✓	✓
UST-5415	✓	✓
UST-5417	✓	✓
UST-5419	✓	✓
UST-547	✓	✓
UST-5524-5	✓	✓
UST-5524-7.5	✓	✓
UST-5531	✓	✓
UST-5534T-7.5 (M00181~) <sup>3</sup>	✓	✓
UST-5539-7.5 (M00884~) <sup>3</sup>	✓	✓
UST-5542 (M00554~) <sup>3</sup>	✓	✓
UST-5543	✓	✓
UST-5545	✓	✓
UST-5546	✓	✓
UST-5548	✓	✓
UST-5551	✓	✓
UST-567	✓	✓
UST-568	✓	✓
UST-5710-7.5 (M02301~) <sup>3</sup>	✓	✓
UST-5712	✓	✓
UST-5713T	✓	✓
UST-574T-7.5 (M00110~) <sup>3</sup>	✓	✓

### Hitachi Aloka Medical (Fujifilm Healthcare)

Model	trophon EPR	trophon2
UST-575-7.5 (M00253~) <sup>3</sup>	✓	✓
UST-579T-7.5 (M00301~) <sup>3</sup>	✓	✓
UST-5813-5	✓	✓
UST-5813N-5	✓	✓
UST-5819T-5 (M00104~) <sup>3</sup>	✓	✓
UST-5820-5	✓	✓
UST-5821-7.5	✓	✓
UST-587I-5	✓	✓
UST-587T-5	✓	✓
UST-588U-5	✓	✓
UST-670P-5 (M00621~) <sup>3</sup>	✓	✓
UST-675P	✓	✓
UST-676P	✓	✓
UST-9101-7.5	✓	✓
UST-9103-5 (M00181~) <sup>3</sup>	✓	✓
UST-9104-5 (M00451~) <sup>3</sup>	✓	✓
UST-9112-5 (M01351~) <sup>3</sup>	✓	✓
UST-9114-3.5 (M00884~) <sup>3</sup>	✓	✓
UST-9115-5 (M00594~) <sup>3</sup>	✓	✓
UST-9116P-5 (M00131~) <sup>3</sup>	✓	✓
UST-9118	✓	✓
UST-9119	✓	✓
UST-9120	✓	✓
UST-9121	✓	✓
UST-9123	✓	✓
UST-9124	✓	✓
UST-9125-7.5	✓	✓
UST-9126	✓	✓
UST-9127	✓	✓
UST-9128	✓	✓

### Hitachi Aloka Medical (Fujifilm Healthcare)

Model	trophon EPR	trophon2
UST-9130	✓	✓
UST-9132I	✓	✓
UST-9132T	✓	✓
UST-9133	✓	✓
UST-9135P	✓	✓
UST-9136	✓	✓
UST-9136U	✓	✓
UST-9137	✓	✓
UST-9146I	✓	✓
UST-9146T	✓	✓
UST-9147	✓	✓
UST-9151	✓	✓
UST-934N-3.5	✓	✓
UST-952-5	✓CPP	✓IPP
UST-953P-5 (M01104~) <sup>3</sup>	✓	✓
UST-954-5 (M00119~) <sup>3</sup>	✓	✓
UST-957-7.5 (M00141~) <sup>3</sup>	✓	✓
UST-972-3.5	✓	✓
UST-975-7.5 (M00107~) <sup>3</sup>	✓	✓
UST-977-5	✓CPP	✓IPP
UST-978-3.5	✓	✓
UST-979-3.5	✓	✓
UST-981-5	✓CPP	✓IPP
UST-984-5	✓CPP	✓IPP
UST-987-7.5 (M00581~) <sup>3</sup>	✓	✓
UST-988-2.5	✓	✓
UST-989-3.5	✓	✓
UST-989D-3.5	✓	✓
UST-990-5	✓	✓
UST-992-5	✓	✓
UST-995-7.5 (M00201~) <sup>3</sup>	✓	✓

### Hitachi Aloka Medical (Fujifilm Healthcare)

Model	trophon EPR	trophon2
UST-MC11-8731 (M00101~) <sup>3</sup>	✓	✓
V5-9-H	✓	✓
VC41VF	✓	✓

### Interson

Model	trophon EPR	trophon2
ER 12 MHz		✓
SP-L01/ SP-DLX200	✓ <sup>T</sup>	✓

### Koelis

Model	trophon EPR	trophon2
K3DEC00-2	✓	✓
K3DEL00-2	✓	✓

### Konica Minolta

Model	trophon EPR	trophon2
C5-2	✓	✓
EC9-3	✓	✓
HL18-4	✓ <sup>T</sup>	✓
L11-3	✓	✓
L14-4	✓	✓
L18-4	✓	✓
MC10-3	✓ <sup>T</sup>	✓
S4-2	✓ <sup>T</sup>	✓
S4-2A	✓ <sup>T</sup>	✓
TV probe A		✓
WL13-3	✓	✓
X20L	✓	✓

### Mindray (Zonare)

Model	trophon EPR	trophon2
2P2	✓	✓
2P2s	✓	✓
2P2P	✓	✓
3C1	✓	✓
3C1s	✓	✓
3C1P	✓	✓
3C5	✓	✓

### Mindray (Zonare)

Model	trophon EPR	trophon2
3C5s	✓	✓
3C5A	✓	✓
3C5P	✓	✓
6C2	✓	✓
6C2s	✓	✓
6C2P	✓	✓
6CV1	✓	✓
6CV1P	✓	✓
6CV1s	✓	✓
6LE5V	✓	✓
6LE5Vs	✓	✓
6LE5VP	✓	✓
7L4	✓	✓
7L4s	✓	✓
7L4A	✓	✓
7L4B	✓	✓
7L4BP	✓	✓
7L4Bs	✓	✓
7L4P	✓	✓
7L5	✓	✓
7L5s	✓	✓
7L5P	✓	✓
7L6	✓	✓
7L6s	✓	✓
7LT4	✓	✓
7LT4E	✓	✓
7LT4s	✓	✓
7LT4P	✓	✓
10L24EA	✓	✓
35C20EA	✓	✓
35C20HA	✓	✓
35C50EA	✓	✓
35C50EB	✓	✓
35C50HA	✓	✓
35C50P	✓	✓
50L60EAV	✓	✓
65C15EA	✓	✓
65C15EAV	✓	✓
65C15HA	✓	✓
65EC10EA	✓	✓
65EC10EB	✓	✓

### Mindray (Zonare)

Model	trophon EPR	trophon2
65EC10EC	✓	✓
65EC10ED	✓	✓
65EC10HA	✓	✓
65EC10HC	✓	✓
65EC10HD	✓	✓
65L50HAV	✓	✓
65EL60EA	✓	✓
6LE7	✓	✓
6LE7P	✓	✓
6LE7s	✓	✓
75L38EA	✓	✓
75L38EB	✓	✓
75L38HA	✓	✓
75L38HB	✓	✓
75L38P	✓	✓
75L50EAV	✓	✓
75L53EA	✓	✓
75L53HA	✓	✓
75L60EA	✓	✓
75L60HB	✓	✓
75LT38EA	✓	✓
75LT40HA	✓	✓
C11-3E	✓	✓
C11-3U	✓	✓
C4-1	✓	✓
C4-1U	✓	✓
C4-1s	✓	✓
C5-1	✓	✓
C5-1E	✓	✓
C5-1s	✓	✓
C5-1U	✓	✓
C5-2	✓	✓
C5-2s	✓	✓
C5-2E	✓	✓
C6-2GE	✓	✓
C6-1	✓	✓
C6-2	✓	✓
C6-2E	✓	✓
C6-2P	✓	✓
C6-2s	✓	✓
C6-2Gs	✓	✓

### Mindray (Zonare)

Model	trophon EPR	trophon2
C6-2GU	✓	✓
C7-3E	✓	✓
C8-3 3D	✓	✓
C9-3	✓	✓
C9-3sp	✓	✓
C9-3Ts	✓	✓
C10-3	✓	✓
C11-3	✓	✓
C11-3s	✓	✓
CB10-4	✓	✓
CB10-4E	✓	✓
CB10-4P	✓	✓
D6-2	✓	✓
D6-2B	✓	✓
D6-2EA	✓	✓
D6-2P	✓	✓
D7-2	✓	✓
D7-2E	✓	✓
D7-2S	✓	✓
D8-2E	✓	✓
D8-2U	✓	✓
DE10-3	✓	✓
DE10-3E	✓	✓
DE10-3s	✓	✓
DE10-3U	✓	✓
DE10-3WU	✓	✓
DE10-3WE	✓	✓
DE10-3Ws	✓	✓
DE11-3	✓	✓
DE11-3E	✓	✓
DE11-3WE	✓	✓
DE11-3WU	✓	✓
DE11-3Ws	✓	✓
DE11-3P	✓	✓
DE11-3s	✓	✓
DE11-3U	✓	✓
E9-3	✓	✓
E9-3 3D	✓	✓
E9-4	✓	✓
L8-3	✓	✓
L9-3	✓	✓

### Mindray (Zonare)

Model	trophon EPR	trophon2
L10-3E	✓ <sup>T</sup>	✓
L10-3s	✓ <sup>T</sup>	✓
L10-5	✓	✓
L11-3U	✓	✓
L11-3VNs	✓	✓
L11-4	✓	✓
L11-4s	✓	✓
L12-3	✓	✓
L12-3E	✓	✓
L12-3RCs	✓	✓
L12-3VNs	✓	✓
L12-4	✓	✓
L12-4s	✓	✓
L13-3	✓	✓
L13-3N	✓	✓
L13-3Ns	✓	✓
L13-3s	✓	✓
L14-3E	✓	✓
L14-3s	✓	✓
L14-3U	✓	✓
L14-3w	✓	✓
L14-3WE	✓	✓
L14-3WU	✓	✓
L14-5sp	✓	✓
L14-5w	✓	✓
L14-5WE	✓	✓
L14-5WU	✓	✓
L14-6	✓	✓
L14-6s	✓	✓
L14-6P	✓	✓
L14-6N	✓	✓
L14-6NE	✓	✓
L14-6NP	✓	✓
L14-6Ns	✓	✓
L14-6WE	✓	✓
L14-6Ws	✓	✓
L14-6WU	✓	✓
L16-4HE	✓	✓
L16-4Hs	✓ <sup>T</sup>	✓
L16-4HU	✓	✓
L20-5	✓	✓

### Mindray (Zonare)

Model	trophon EPR	trophon2
L20-5E	✓	✓
L20-5s	✓	✓
L20-5U	✓	✓
L7-3	✓	✓
L7-3E	✓	✓
L7-3s	✓	✓
L9-3E	✓	✓
L9-3s	✓	✓
L9-3U	✓	✓
LM14-6E	✓	✓
LM14-6s	✓	✓
LM16-4U	✓	✓
P4-1c	✓	✓
P4-2	✓	✓
P4-2E	✓	✓
P4-2NE	✓	✓
P4-2Ns	✓	✓
P4-2s	✓	✓
P7-3	✓	✓
P7-3c	✓	✓
P7-3E	✓	✓
P7-3P	✓	✓
P7-3s	✓	✓
P7-3U	✓	✓
P8-2	✓	✓
P8-2s	✓	✓
P8-2P	✓	✓
P8-2U	✓	✓
P10-4E	✓	✓
P10-4s	✓	✓
P10-4U	✓	✓
P12-4	✓	✓
P12-4s	✓	✓
SC5-1E	✓	✓
SC5-1N	✓	✓
SC5-1NE	✓	✓
SC5-1Ns	✓	✓
SC5-1U	✓	✓
SC6-1E	✓	✓
SC6-1s	✓	✓
SC6-1U	✓	✓

### Mindray (Zonare)

Model	trophon EPR	trophon2
SC8-2E	✓	✓
SC8-2s	✓	✓
SC8-2U	✓	✓
SD8-1	✓	✓
SD8-1U	✓	✓
SD8-1E	✓	✓
SD8-1s	✓	✓
SP3-1U	✓	✓
SP5-1	✓	✓
SP5-1E	✓	✓
SP5-1N	✓	✓
SP5-1Ns	✓	✓
SP5-1s	✓	✓
SP5-1U	✓	✓
SP9-2U	✓	✓
V10-4	✓	✓
V10-4B	✓	✓
V10-4BP	✓	✓
V10-4Bs	✓	✓
V10-4P	✓	✓
V10-4s	✓	✓
V11-3	✓	✓
V11-3H	✓	✓
V11-3HB	✓	✓
V11-3HBs	✓	✓
V11-3s	✓	✓
V11-3B	✓	✓
V11-3BE	✓	✓
V11-3E	✓	✓
V11-3HBE	✓	✓
V11-3HE	✓	✓
V11-3Hs	✓	✓
V11-3HU	✓	✓
V11-3WE	✓	✓
V11-3WS	✓	✓
XP5-1U	✓	✓
XP6-1HU	✓	✓
XP6-1U	✓	✓
a3P		✓
a3PA		✓
a3P-W		✓

### Mindray (Zonare)

Model	trophon EPR	trophon2
a3P-X		✓
a5M		✓
a5MA		✓
i3P		✓
i3PA		✓
i5M		✓
i5MA		✓

### Philips

Model	Series	trophon EPR	trophon2
11-3L		✓	✓
15-6L		✓	✓
3D6-2		✓	✓
3D8-4		✓	✓
3D9-3v		✓	✓
BP10-5ec		✓	✓
C10-3v		✓	✓
C10-4ec		✓	✓
C3540		✓	✓
C5040		✓	✓
C5-1		✓	✓
C5-2		✓	✓
C5-2	Lumify		✓
C6-2		✓	✓
C6-2 Compact		✓	✓
C6-3		✓	✓
C8-4v		✓	✓
C8-5 Compact		✓	✓
c8-5		✓	✓
C9-2		✓	✓
C9-3io		✓	✓
C9-3v		✓	✓
C9-4		✓	✓
C9-4ec			✓
C9-4v		✓	✓
C9-4v Compact		✓	✓
C9-5ec		✓	✓
CA5-2		✓	✓

### Philips

Model	Series	trophon EPR	trophon2
E6509		✓	✓
EI18-4		✓	✓
EI18-4 EMT		✓	✓
L1038		✓	✓
L11-3		✓	✓
L12-3		✓	✓
L12-3 Ergo		✓	✓
L12-4		✓	✓
L12-4	Lumify, Xperius		✓
L12-5		✓	✓
L12-5 38mm		✓	✓
L12-5 50 mm Compact		✓	✓
L12-5 50mm		✓	✓
L15-7io		✓	✓
L17-5		✓	✓
L18-5		✓	✓
L5035		✓	✓
L5040		✓	✓
L7535		✓	✓
L7540		✓	✓
L8-4		✓	✓
L9-3		✓	✓
Mc7-2		✓	✓
mC12-3		✓	✓
PA4-2		✓	✓
S12		✓	✓
S12-4		✓	✓
s3		✓	✓
S3-1		✓	✓
S4		✓	✓
S4-1		✓	✓
S4-1	Lumify		✓
S4-2		✓	✓

### Philips

Model	Series	trophon EPR	trophon2
S4-2		✓	✓
Compact			
S5-1		✓	✓
S5-2		✓	✓
s7510		✓	✓
s8		✓	✓
S8-3		✓	✓
S8-3			
Compact		✓	✓
S9-2		✓	✓
S12-4		✓	✓
Compact			
V6-2		✓	✓
V7-3		✓	✓
V8-4		✓	✓
V9-2		✓	✓
V9-4v		✓	✓
VL13-5		✓	✓
VL13-5			
Compact		✓	✓
X3-1		✓	✓
x4		✓	✓
X5-1		✓	✓
X5-1c		✓	✓
X6-1		✓	✓
X7-2		✓	✓
XL14-3		✓	✓

### Procept Biorobotics

Model	trophon EPR	trophon2
HYDROS TRUS Probe HU1000	✓	✓

### Prosonic

Model	trophon EPR	trophon2
EC9-4/10EPU	✓ <sup>T</sup>	
L5-10/40EPN <sup>1</sup>	✓ <sup>T</sup>	

### Samsung Medison

Model	trophon EPR	trophon2
3D2-6	✓	✓
3D2-6ET	✓	✓
3D4-8ET	✓	✓
3D4-9	✓	✓
3D4-9ES	✓	✓
C2-6	✓	✓
C5-8	✓	✓
CA1-7A	✓	✓
CA1-7AD	✓	✓
CA1-7S	✓	✓
CA2-8A	✓	✓
CA2-8AD	✓	✓
CA2-9A	✓	✓
CA2-9AD	✓	✓
CA3-10A	✓	✓
CA4-10M	✓ <sup>T</sup>	✓
CF2-8	✓	✓
CF4-9	✓	✓
CMV1-10	✓	✓
CS1-4	✓	✓
CV1-8A	✓	✓
CV1-8AD	✓	✓
E3-12A	✓	✓
EA2-11AR	✓	✓
EA2-11AV	✓ <sup>CPP</sup>	✓ <sup>IPP</sup>
EA2-11B	✓	✓
EC4-9	✓	✓
ER4-9	✓	✓
ER4-9/10ED	✓ <sup>CPP</sup>	✓ <sup>IPP</sup>
miniER7	✓	✓
EV2-10A	✓	✓
EV3-10B	✓	✓
EV4-9/10ED		✓ <sup>IPP</sup>
EVN4-9	✓	✓
L3-12A	✓	✓
L4-7	✓	✓
L5-13IS	✓	✓
L7-16	✓	✓
L7-16IS	✓	✓
LA2-9A	✓	✓
LA2-9S	✓	✓

### Samsung Medison

Model	trophon EPR	trophon2
LA2-14A	✓	✓
LA3-14A	✓	✓
LA3-14AD	✓	✓
LA3-16A	✓	✓
LA3-16AD	✓	✓
LA3-16AI	✓	✓
LA3-22AI	✓	✓
LA4-18A	✓	✓
LA4-18B	✓	✓
LF5-13	✓	✓
LM2-18	✓	✓
LN5-12	✓	✓
LS6-15	✓	✓
LV3-14A	✓	✓
P2-4AA	✓	✓
P2-4BA	✓	✓
P3-8	✓	✓
P3-8CA	✓	✓
P4-12	✓	✓
PE2-4	✓	✓
PM1-6A	✓	✓
SC1-6	✓	✓
SP3-8	✓	✓
V2-6	✓	✓
V4-8	✓	✓
V5-9	✓	✓
V6-12	✓	✓
VE4-8	✓	✓
VR5-9	✓ <sup>CPP</sup>	✓ <sup>IPP</sup>

### Siemens

Model	Series	trophon EPR	trophon2
3V2c	-	✓	✓
4P1	ACUSON S1000 ACUSON S2000 ACUSON S3000	✓	✓

### Siemens

Model	Series	trophon EPR	trophon2
4V1	ACUSON S1000 ACUSON S2000 ACUSON S3000 ACUSON Sequoia ACUSON Redwood	✓	✓
4V1c	ACUSON S1000 ACUSON S2000 ACUSON S3000 ACUSON SC2000	✓	✓
5.0C5 0+	-	✓	✓
5.0L45	-	✓	✓
5.0P10	-	✓	✓
5C1	ACUSON Redwood, ACUSON Sequoia, SN ≥2109XXX X	✓	✓
5P1	ACUSON Juniper	✓	✓
5V1	ACUSON Sequoia ACUSON Redwood	✓	✓
5V2c	-	✓	✓
5Z1	ACUSON Sequoia	✓	✓
6C1	ACUSON Juniper	✓	✓
6C2	ACUSON S1000 ACUSON S2000 ACUSON S3000	✓	✓



**Siemens**

Model	Series	trophon EPR	trophon2
7.5L70	-	✓	✓
7.5L75S	-	✓	✓
7CF1	ACUSON S1000 ACUSON S2000 ACUSON S3000	✓	✓
7CF2	ACUSON S1000 ACUSON S2000 ACUSON S3000	✓	✓
8L5T	-	✓	✓
8V3	ACUSON S1000 ACUSON S2000 ACUSON S3000 ACUSON SC2000 ACUSON Redwood ACUSON Sequoia	✓	✓
8V3c	-	✓	✓
8V4	ACUSON Juniper	✓	✓
9EC4	ACUSON Redwood ACUSON Sequoia	✓	✓
9EVF4	ACUSON S1000 ACUSON S2000 ACUSON S3000	✓	✓
9L4	ACUSON S1000 ACUSON S2000 ACUSON S3000 ACUSON SC2000	✓	✓

**Siemens**

Model	Series	trophon EPR	trophon2
9MC3	ACUSON Juniper	✓	✓
9VC2	-	✓	✓
9VE4	-	✓	✓
9VE3	ACUSON Juniper	✓	✓
10L4	ACUSON Redwood ACUSON Sequoia	✓	✓
10MC3	ACUSON NX2 ACUSON NX2 Elite ACUSON NX3 ACUSON NX3 Elite ACUSON Juniper	✓	✓
10V4	ACUSON S1000 ACUSON S2000 ACUSON S3000 ACUSON SC2000 ACUSON Redwood ACUSON Juniper ACUSON Sequoia	✓	✓
11L4	ACUSON Juniper ACUSON NX3 ACUSON NX3 Elite	✓	✓
11M3	ACUSON Juniper	✓	✓
13L4	ACUSON Juniper	✓	✓

**Siemens**

Model	Series	trophon EPR	trophon2
14L5	ACUSON S1000 ACUSON S2000 ACUSON S3000 ACUSON Sequoia ACUSON Redwood	✓	✓
14L5 SP	ACUSON S1000 ACUSON S2000 ACUSON S3000	✓	✓
15L4	ACUSON Sequoia	✓	✓
16L4	ACUSON Juniper	✓	✓
18H5	ACUSON Juniper	✓	✓
18H6	ACUSON Sequoia	✓	✓
CA123	-	✓	✓
CA431	-	✓	✓
C5-2	ACUSON Freestyle	✓ WUPH-A	✓ WUPH-A
C5F1	-	✓	✓
C6-2	-	✓	✓
C7F2	-	✓	✓
C8-5	ACUSON NX3 Elite	✓	✓
CH4-1	-	✓	✓
CH5-2	ACUSON P500 ACUSON NX2 ACUSON NX2 Elite ACUSON NX3 ACUSON NX3 Elite	✓	✓
CH5-2	ACUSON Freestyle	✓ WUPH-A	✓ WUPH-A
CH6-2	-	✓	✓

**Siemens**

Model	Series	trophon EPR	trophon2
CW2	ACUSON Juniper, ACUSON Redwood, ACUSON NX2 Elite, ACUSON NX3 Elite, ACUSON P500, ACUSON S1000, ACUSON S2000, ACUSON S3000, ACUSON SC2000, ACUSON Sequoia		✓
CW5	ACUSON Juniper, ACUSON Redwood, ACUSON NX2 Elite, ACUSON NX3 Elite, ACUSON P500, ACUSON S1000, ACUSON S2000, ACUSON S3000, ACUSON Sequoia		✓
DAX	ACUSON Sequoia	✓	✓
EC-10C5	-	✓	✓

### Siemens

Model	Series	trophon EPR	trophon2			
EC9-4	ACUSON NX2	✓	✓			
	ACUSON NX2 Elite					
	ACUSON NX3					
	ACUSON NX3 Elite					
	ACUSON S1000					
	ACUSON S2000					
	ACUSON S3000					
	ACUSON P500					
	EC10-5W			-	✓	✓
	EC9-4w			-	✓	✓
Endo V 3D (EV8F5)	-	✓	✓			
Endo V II	-	✓	✓			
EV-8C4	ACUSON S1000	✓	✓			
	ACUSON S2000 ACUSON S3000					
EV9-4	ACUSON X150	✓	✓			
	ACUSON X300 PE					
	ACUSON X300					
	SONOLINE G40					
	ACUSON X500					
	SONOLINE G50					
	SONOLINE G60 S					
	SONOVIST A FX					
	SONOVIST A FX PE					
	EV9F4			-	✓	✓

### Siemens

Model	Series	trophon EPR	trophon2
L8-3	ACUSON Freestyle	✓ WUPH-A	✓ WUPH-A
L10-5	-	✓	✓
L13-5	ACUSON Freestyle	✓ WUPH-A	✓ WUPH-A
L17-5	ACUSON Freestyle	✓ WUPH-A	✓ WUPH-A
LA435	-	✓	✓
LA522E	-	✓	✓
LA523	-	✓	✓
MC9-4	ACUSON S1000	✓	✓
	ACUSON S2000		
	ACUSON S3000		
PA023E	-	✓	✓
PA122E	-	✓	✓
PA230E	-	✓	✓
P10-4	-	✓	✓
P4-2	ACUSON NX2	✓	✓
	ACUSON NX2 Elite		
	ACUSON NX3		
	ACUSON NX3 Elite ACUSON P500		
P8-4	ACUSON P500	✓	✓
	ACUSON NX3 Elite SN≤72915007 SN ≥72915008		
P9-4	-	✓	✓
PH4-1	-	✓	✓
PX4-1	-	✓	✓

### Siemens

Model	Series	trophon EPR	trophon2
VF10-5	ACUSON NX2	✓	✓
	ACUSON NX2 Elite		
	ACUSON NX3		
	ACUSON NX3 Elite		
	ACUSON P500		
	ACUSON P500		
VF13-5	ACUSON P500	✓	✓
VF13-5 SP	ACUSON NX3 Elite	✓	✓
VF8-3	-	✓	✓
VF16-5	ACUSON NX3 Elite, ACUSON P500	✓ <sup>T</sup>	✓
VFX1 3-5	-	✓	✓
VFX9-4	-	✓	✓
8VC3	-	✓	✓
9C2	-	✓ <sup>T</sup>	✓
7L2	-	✓	✓
7VC2	-	✓	✓
10EV3	-	✓	✓
14L4	-	✓	✓

### SIUI

Model	trophon EPR	trophon2
ECBP-1	✓	✓

### Sonoscanner

Model	trophon EPR	trophon2
(TL074-160301014)		✓

### Sonoscape

Model	trophon EPR	trophon2
BCL10-5		✓

### Sonoscape

Model	trophon EPR	trophon2
EC9-5	✓	✓
VC6-2	✓	✓
VE9-5	✓	✓
6V1	✓	✓
6V3	✓	✓

### Sonosite (Fujifilm)

Model	trophon EPR	trophon2
C10-3	✓	✓
C11	✓	✓
C11e	✓	✓
C11n	✓	✓
C11x	✓	✓
C11XP	✓	✓
C15	✓	✓
C15e	✓	✓
C35x	✓	✓
C35xp	✓	✓
C5-1	✓	✓
C60	✓	✓
C60e	✓	✓
C60n	✓	✓
C60v	✓	✓
C60x	✓	✓
C60xf	✓	✓
C60xi	✓	✓
C60xp	✓	✓
C8	✓	✓
C8e	✓	✓
C8x	✓	✓
HFL38	✓	✓
HFL38x	✓	✓
HFL38xi	✓	✓
HFL38xp	✓	✓
HFL50x	✓	✓
HFL50xp	✓	✓
HSL25x	✓	✓
HSL25xp	✓	✓
IC10-3	✓	✓
ICT	✓	✓
ICTe	✓	✓

### Sonosite (Fujifilm)

Model	trophon EPR	trophon2
ICTn	✓	✓
ICTx	✓	✓
ICTxp	✓	✓
L12-3	✓ <sup>T</sup>	✓
L13-6	✓	✓
L15-4	✓ <sup>T</sup>	✓
L19-5	✓	✓
L25	✓	✓
L25e	✓	✓
L25n	✓	✓
L25v	✓	✓
L25x	✓	✓
L25xp	✓	✓
L38	✓	✓
L38e	✓	✓
L38n	✓	✓
L38v	✓	✓
L38x	✓	✓
L38xi	✓	✓
L38xp	✓	✓
P5-1	✓	✓
P10	✓	✓
P10x	✓	✓
P10xp	✓	✓
P11-3	✓	✓
P17	✓	✓
P21n	✓	✓
P21v		✓
P21x	✓	✓
P21xp	✓	✓
rC60xi	✓	✓
rP19X	✓	✓
rP19xp	✓	✓
SLA	✓	✓
SLAx	✓	✓

### Supersonic Imagine (Hologic)

Model	Series	trophon EPR	trophon 2
C6-1X (SSIP95 101)	MACH series	✓	✓
C9-2X (SSIP95 105)	MACH series	✓	✓
LH20-6 (SSIP95 104)	MACH series	✓	✓
L18-5 (SSIP95 100)	Aixplorer /MACH	✓	✓
P5-1X (SSIP95 107)	MACH series	✓	✓
SE12-3 GenII (SSIP92 068)	Aixplorer /MACH	✓	✓
SEV12-3 Gen II (SSIP93 189)	Aixplorer	✓	✓
SLH20-6 Gen II (SSIP92 164)	Aixplorer	✓	✓
SLH20-6 Gen III (SSIP93 164)	Aixplorer	✓	✓
XC6-1 Gen II (SSIP92 167)	Aixplorer	✓	✓
XC6-1 (SSIP92 167)	Aixplorer /MACH	✓	✓
XP5-1 Gen II (SSIP92 161)	Aixplorer	✓	✓

### Terason

Model	trophon EPR	trophon2
4V2A	✓ <sup>T</sup>	✓
5C2A	✓ <sup>T</sup>	✓
8EC4A	✓ <sup>T</sup>	✓
8L2	✓ <sup>T</sup>	✓
8V3A	✓ <sup>T</sup>	✓
9MC3	✓ <sup>T</sup>	✓
10EC4	✓	✓
15L4	✓	✓
15L4A	✓	✓
16HL7		✓
16L5	✓	✓
16SL5	✓	✓

### UltraSonix

Model	trophon EPR	trophon2
C5-2/60	✓	
C5-2/60 GPS	✓	
EC9-5/10	✓ <sup>T</sup>	
L14-5/38 <sup>2</sup>	✓ <sup>T</sup>	
L14-5/38 GPS	✓	
L14-5W/60	✓	